

Systems Reference Library

IBM System/360 System Summary

This publication provides basic information about the IBM System/360; its objective is to help readers achieve a general understanding of this data processing system and of the interrelationships of its models and components. The system concepts, features, individual models, and programming systems are briefly discussed, and the input/output devices and terminals are listed.

It is assumed that the reader has a basic knowledge of data processing systems, as given in the *Introduction to IBM Data Processing Systems*, GC20-1684.

More detailed information about System/360 is available in the *IBM System/360 Principles of Operation*, GA22-6821. Publications further describing the individual System/360 models, programming systems, input/output devices, and teleprocessing equipment are listed in the *IBM System/360 and System/370 Bibliography*, GA22-6822, and the *IBM Teleprocessing Bibliography*, GA24-3089.

This publication does not apply to System/360 Model 20. All Model 20 publications are listed in the *IBM System/360 Model 20 Bibliography*, GA26-3565.

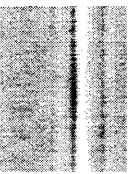
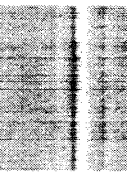
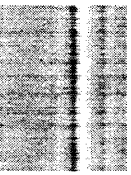
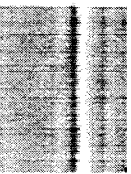
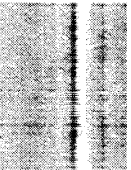
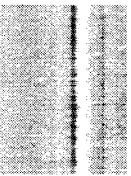

Thirteenth Edition (January 1974)

This major revision obsoletes GA22-6810-11 and Technical Newsletters GN22-0344 and GN22-0450.

Numerous changes were made in this manual. Among the changes is the deletion of the descriptions of the input/output devices and terminals. In general, any significant technical change (revision, addition, or deletion) is indicated by a vertical bar to the left of the change

Brief descriptions of most input/output devices and terminals attachable to System/360 are in the *IBM System/370 System Summary*, GA22-7001. Attachment information for these input/output devices and terminals is in the *IBM System/360 Input/Output Configurator*, GA22-6823.

Changes are periodically made to the specifications herein; before using this publication in connection with the operation of IBM systems, refer to the latest *IBM System/360 and System/370 Bibliography*, GA22-6822 and associated technical newsletters for the editions that are applicable and current.

Requests for copies of IBM publications should be made to your IBM representative or to the IBM branch office serving your locality.

This manual was prepared by the IBM System Products Division, Product Publications, Dept. B98, P. O. Box 390, Poughkeepsie, N. Y. 12602. A form for readers' comments is provided at the back of this publication. If the form has been removed, comments may be sent to the above address. Comments become the property of IBM.

Contents

Section 1. Introduction to IBM System/360	1-1	Specific Operating Systems	4-1
		Programming Systems Glossary	4-3
Section 2. System/360 Basic Structure	2-1	Section 5. Teleprocessing, Data Acquisition, and Process Control	5-1
Data Formats	2-1	Teleprocessing	5-1
Data Representation	2-1	Requirements of a Teleprocessing System	5-2
Main Storage	2-2	Transmission Directions and Modes	5-2
Addressing	2-3	Terminal Connections to Communications Lines	5-2
Data Positioning	2-3	Modems	5-3
Performance Factors	2-4	Data Acquisition and Process Control	5-3
Central Processing Unit	2-4		
Arithmetic and Logic Operations	2-4	Section 6. System/360 Models	6-1
Instruction Formats	2-5	Model 22	6-1
System Control Panel	2-6	System Components	6-2
Input/Output	2-6	Programming Support	6-2
Channels	2-6	Model 25	6-3
I/O Devices	2-8	System Components	6-3
Control Units	2-8	Programming Support	6-4
I/O Interface	2-8	Model 30	6-5
Interruption System	2-8	System Components	6-5
		Programming Support	6-6
Section 3. System/360 Features	3-1	Model 40	6-7
Main Storage Features	3-1	System Components	6-7
Processor Storage Capacities	3-1	Programming Support	6-8
Large-Capacity Storage (LCS), or IBM 2361		Model 50	6-9
Core Storage	3-1	System Components	6-9
Shared Main Storage	3-1	Programming Support	6-10
Storage Protection	3-1	Model 65	6-11
Central Processing Unit Features	3-3	System Components	6-11
Instruction Sets	3-3	Programming Support	6-12
Decimal Feature	3-3	Model 67	6-13
Floating-Point Feature	3-3	System Components	6-14
Extended-Precision Floating-Point Feature	3-3	Programming Support	6-15
Direct Control and External Interrupt	3-3	Model 75	6-16
Byte-Oriented Operand	3-3	System Components	6-16
Dynamic Address Translation	3-3	Programming Support	6-17
Emergency Power-Off Control	3-4	Model 195	6-18
High-Speed Buffer Storage	3-4	System Components	6-18
Timers	3-4	Programming Support	6-19
Time Sharing	3-4		
Channel Features	3-4	Section 7. Input/Output Devices	7-1
Channel-to-Channel Adapter	3-4		
System Features	3-4	Section 8. Teleprocessing Terminals	8-1
Compatibility Features for Other IBM Systems	3-4		
System Partitioning (Duplex Model 67-2)	3-5	Index	X-1
Section 4. System/360 Programming Systems	4-1		
Basic Programming Support (BPS)	4-1		
Special Systems Support	4-1		
Operating Systems—General Facts	4-1		



IBM System/360 Model 22

Section 1. Introduction to IBM System/360

IBM System/360 provides a wide range of computing versatility and power combined with exceptional reliability and efficiency. The different models within System/360 are identical in concept and compatible in programming, but are scaled in size, speed, and cost to fit the needs of different users. The many ways System/360 meets these needs are discussed in the following paragraphs.

System/360 is a general-purpose system. System/360 can be tailored for a wide variety of applications:

1. Commercial applications, which require decimal arithmetic, variable-length fields, and editing capabilities.
2. Scientific applications, which require larger storage capacities and high-speed binary arithmetic.
3. Communications, which often requires a large number of communication terminals and fast response.
4. Control applications, which require fast internal processing speeds and high reliability.
5. Any combination of the preceding applications.

System/360's design is open-ended. This permits System/360 to easily expand and to incorporate new features, devices, and technology. One example is the system's capability of addressing over 16 million bytes of main storage, thereby anticipating larger storage needs than those already met. Another example is the use of an eight-bit character code that allows for as many as 256 characters, permitting easy code expansion for future needs.

System/360 offers a wide choice of models, each with an extensive selection of facilities. The different models offer users a choice of performance ranges. Each model also has a wide selection of main storage capacities, I/O devices, programming support, and features, permitting the system to be tailored to the user's needs. As his needs change, his system can often be modified correspondingly.

System/360 offers system compatibility. When expansion of data processing operations requires a larger model of System/360, system compatibility ensures easy transition. This characteristic permits programs that operate on one model of System/360 to operate on other models that have the necessary configuration and features.

Transition to System/360 from most other IBM systems is facilitated by the compatibility features, which are combinations of circuitry and programming that enable System/360 to execute programs written for other IBM systems. In many cases, the programs are executed faster on the System/360 than on the system for which they were written.

System/360 has self-supervision capabilities. This is due primarily to the System/360 interruption system and to the control programs. The *interruption system* permits the central processing unit (CPU) to:

1. Quickly change state as a result of conditions in the CPU itself, in the input/output (I/O) units, or external to the system.
2. Identify the type of interruption.
3. Store the current status information to permit later resetting of the status that the CPU had before the interruption.

The interruption system operates in conjunction with a *control program*. System/360 models are designed to operate with a control program, an integral part of most System/360 programming systems. With a control program:

1. Data and programs processed by System/360 are systematically organized, identified, stored, and retrieved.
2. A continuous series of jobs can be performed by System/360 with little or no operator intervention.
3. Several data processing tasks can be performed concurrently, thereby increasing the total throughput of System/360.

System/360 permits easy attachment of many different I/O devices that can operate concurrently with data processing. To overlap data processing and I/O operations efficiently, System/360 uses channels; these units relieve the central processing unit of the direct handling of I/O operations. One type of channel (the selector channel) is used primarily to control high-speed I/O devices, such as magnetic tape units and disk storage units; another type (the multiplexer channel) simultaneously controls a number of lower-speed devices, such as communication terminals, printers, and punched-card devices. The channels operate through the System/360 I/O interface, which provides the system with a uniform method of easily attaching many

different I/O devices. Both the channels and the I/O interface facilitate the attachment of new I/O devices, developed to meet the needs of users.

System/360 offers high reliability. This is done by using more reliable components and circuits, parity checking, error-checking and correction circuitry, the System/360 interruption system, instruction retry, and system compatibility.

The reliability of System/360 is significantly higher than that of its predecessors because of the reliability of its basic component circuitry, which may be solid logic technology (SLT) or any of the more advanced circuit technologies. Parity checking, used on all

models of System/360, increases reliability by monitoring both data and instructions for invalid information. On some models, parity checking is complemented by error-checking and correction circuitry. Error checking is also done during program execution by the interruption system, clearly separating interruptions caused by either machine or programming errors, thus helping to minimize downtime. Systems equipped with the instruction retry feature automatically attempt to re-execute failing instructions, thereby reducing the possibility of program interruption. System compatibility contributes to reliability by permitting the coupling of units to form a system that is operational even though some components may fail.

Section 2. System/360 Basic Structure

The basic structure of a System/360 model (Figure 2-1) consists of main storage, a central processing unit (CPU), one or more channels, and input/output devices generally attached to the channels through channel units and the System/360 I/O interface.

Data Formats

The system transmits data between main storage and CPU in multiples of eight bits. Each eight-bit unit of data is called a *byte*, the basic building block of all formats in System/360. A ninth bit, the *parity* or *check* bit, is transmitted with each byte and carries odd parity in the byte. The parity bit cannot be affected by the program; its only purpose is to cause an interruption when a parity error is detected. In this manual, references to data exclude the mention of the associated parity bits.

Bytes may be handled separately, or they may be grouped in *fields*. The *halfword*, *word*, and *doubleword* are fields of consecutive bytes; a halfword has two bytes, a word has four bytes, and the doubleword

has eight bytes. These fields make up the basic fixed-length data formats (Figure 2-2).

Data formats are either fixed-length or variable-length. During processing, their field length is either implied by the operation to be performed or it is stated explicitly as part of the instruction.

Data Representation

In System/360, data (whether numeric, alphabetic, or alphanumeric) is processed in multiples of an eight-bit byte. The data may be in binary form (as numeric data for most scientific computations) or it may be in a binary *code*. Coding permits data to be represented by characters (for example, 1, 2, A, B, and *) on devices such as card readers, visual display units, and printers. These devices are code-dependent; that is, their operation depends on the code used to represent the characters.

The eight-bit byte provides for as many as 256 characters, which allows for future code expansion and permits System/360 to accept most present and future

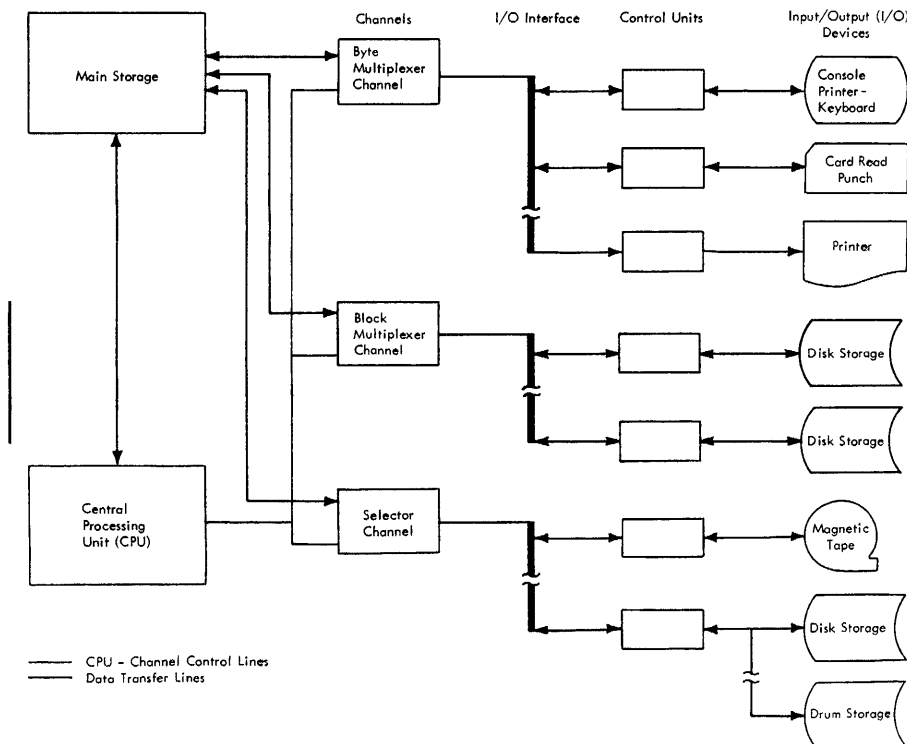

Figure 2-1. Organization of a Representative System/360 Model

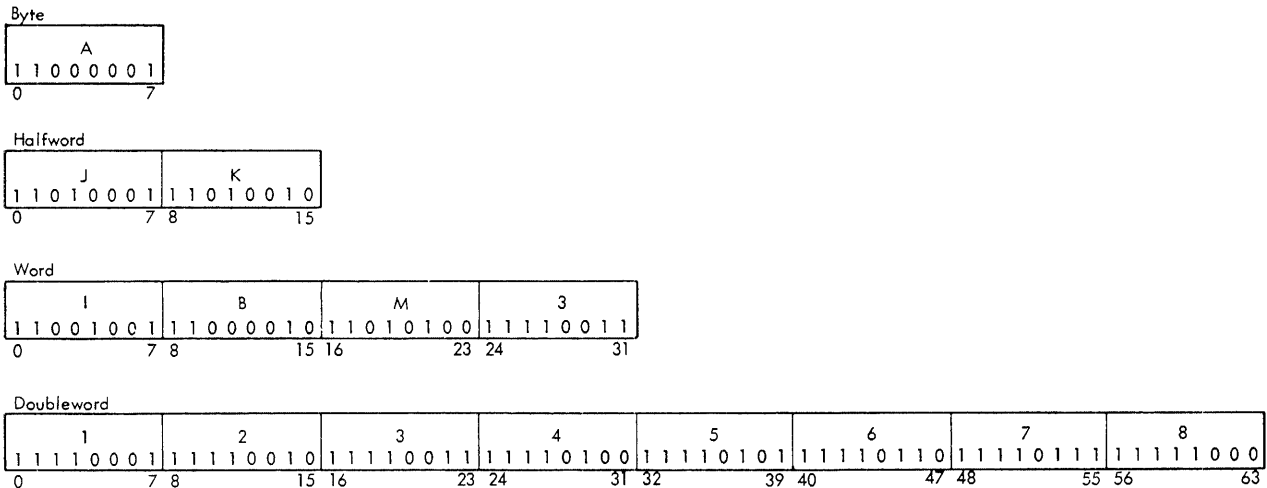

Figure 2-2. Basic Fixed-Length Data Formats (with EBCDIC-Coded Data)

codes. The most commonly used character code in System/360 is the extended binary-coded-decimal interchange code (EBCDIC). The bit positions in EBCDIC (Figure 2-3) are numbered the same as those of bytes (left to right, 0-7). Another code that may be used in place of EBCDIC is the USA Standard Code for Information Interchange (USASCII) extended to eight bits, in this manual referred to as USASCII-8.

Main Storage

Main storage, housed with the CPU in the smaller models and housed separately in the larger ones, provides the system with directly-addressable fast-access storage of data. Both data and programs must be loaded into main storage (from input devices) before they can be processed.

EBCDIC Bit Order
0 1 2 3 4 5 6 7

Bit Positions	0123	4567														
	0000	0001	0010	0011	0100	0101	0110	0111	1000	1001	1010	1011	1100	1101	1110	1111
0000																
0001																
0010																
0011																
0100	Blank										c	.	<	(+	
0101	&										!	\$	*)	;	⌋
0110	-										,	%	_	>	?	
0111											:	#	@	'	=	"
1000		a	b	c	d	e	f	g	h	i						
1001		j	k	l	m	n	o	p	q	r						
1010			s	t	u	v	w	x	y	z						
1011																
1100		A	B	C	D	E	F	G	H	I						
1101		J	K	L	M	N	O	P	Q	R						
1110			S	T	U	V	W	X	Y	Z						
1111		0	1	2	3	4	5	6	7	8	9					

Figure 2-3. EBCDIC Character Codes (Excluding Control Character Representations)

Addressing

Byte locations in main storage are consecutively numbered starting with 0; each number is the address of the corresponding byte. A group of bytes in storage is addressed by the leftmost byte of the group. The number of bytes in the group is either implied by the instruction format or explicitly defined by the instruction itself. Anticipating future storage needs, the addressing arrangement uses a 24-bit binary address, which gives System/360 the capability of addressing as many as 16,777,216 bytes of storage. This set of main-storage addresses includes some locations reserved for special purposes.

Data Positioning

Restrictions on the positioning of data in storage depend on whether a data field is variable- or fixed-length. *Variable*-length fields may start on any byte location, but *fixed*-length fields (such as halfwords, words, and doublewords) in most models must be located in main storage on *integral boundaries*. A boundary is integral for a unit of data when its main storage address is a multiple of that unit's length in bytes. For example, halfwords (two bytes) must have main storage addresses that are multiples of two. Figure 2-4 shows integral boundaries for the common units of data, showing simplified main storage addresses as

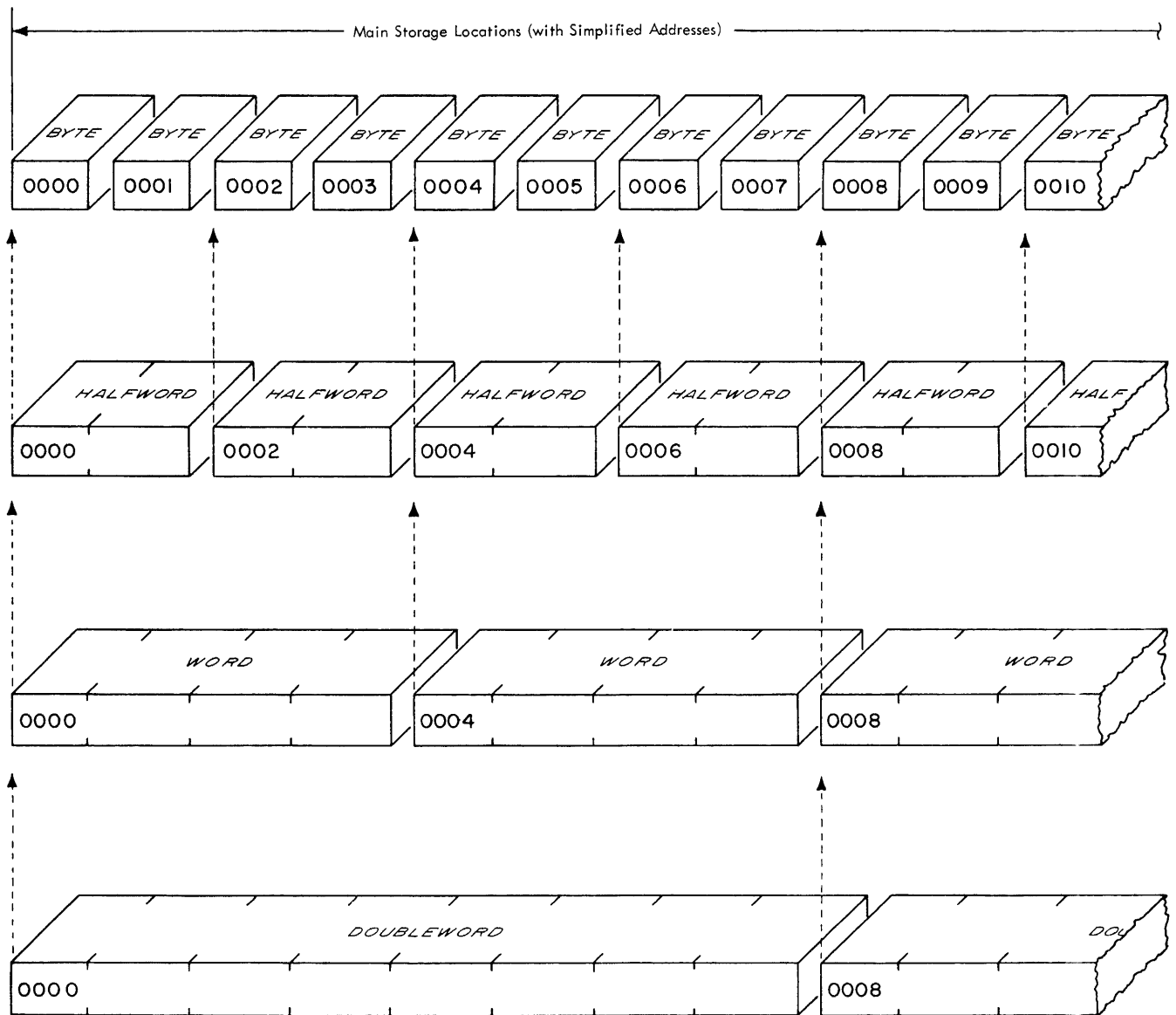

Figure 2-4. Representative Integral Boundaries for Halfwords, Words, and Doublewords in Main Storage

four-digit decimal numbers (0000, 0001, 0002, etc.) rather than the 24-digit binary numbers actually used. Sequential halfword addresses are shown in Figure 2-4 as 0000, 0002, 0004, etc. For integral boundaries, words (four bytes) must have addresses that are multiples of four (shown in Figure 2-4 as 0000, 0004, 0008, etc.), and doublewords (eight bytes) must have addresses that are multiples of eight (shown in Figure 2-4 as 0000, 0008, 0016, etc.).

For exception to the boundary restriction, see "Byte-Oriented Operand" discussed in Section 3.

Performance Factors

The variety of main-storage units available for the System/360 models permits the system to be tailored to suit the individual needs of the user. The units differ in capacities, access widths, cycle times, and degrees of interleaving.

Depending on the model, storage capacities range from 16K (16,384) bytes to 4,096K (4,194,304) bytes. (In this manual, 1K = 1,024.) Additional directly-addressable storage is available for several models, permitting main storage increases (in rounded numbers) of one to eight million bytes.

Storage Access Width is the number of bytes transferred to or from main storage in each access. As access width increases, the quantity of data that may be transferred per unit time increases. The width, which is model-dependent, ranges from 1 to 16 bytes.

Storage Cycle Time is a measure of storage speed and is defined as the length of time that main storage is busy whenever a reference is made to it. The shorter the cycle time, the greater the number of operations that can be performed in any time interval. Fixed for each model, this cycle time ranges from 0.75 to 2.5 microseconds.

Storage interleaving, available with the larger System/360 models, increases the number of main-storage accesses started in a storage cycle, thereby significantly increasing the amount of data accessed per unit time. With interleaving, the number of accesses started during a storage cycle can be 2, 4, 8, or 16, depending on the main-storage capacity.

Central Processing Unit

The central processing unit (CPU) is the controlling center of System/360. It provides facilities for:

- Addressing main storage.
- Fetching and storing data.
- Arithmetic and logical processing of data.
- Executing instructions in a desired sequence.
- Initiating communication between main storage and input/output (i/o) devices.

The CPU also provides 16 general registers and 4 floating-point registers. These registers are accessible

to the programmer and are capable of receiving data, holding it, permitting it to be operated on, and transferring it. The *general registers* are used primarily for fixed-point, logic, and addressing operations. The *floating-point registers* are used only for floating-point arithmetic.

Two major sections of the CPU are the system control section and the arithmetic/logic unit. The system control section directs the sequential accessing of instructions and coordinates both instruction execution and storage fetches. The arithmetic/logic unit, as its name implies, performs the arithmetic and logic operations.

Arithmetic and Logic Operations

The arithmetic and logic operations fall into four classes:

- Decimal arithmetic
- Fixed-point arithmetic
- Floating-point arithmetic
- Logic operations

These classes differ in the data formats and field lengths used, the registers involved, and the operations provided.

Decimal Arithmetic

Decimal arithmetic, used principally for commercial applications, is performed on signed decimal numbers. Generally, decimal data entering and leaving the system via devices such as card reader-punches and printers is in *zoned* format (Figure 2-5). But, for processing and for storage in direct-access and magnetic-tape devices, decimal data is in *packed* format (Figure 2-6). Packing fits two decimal digits (or one digit and sign) per byte. Because only four binary digits are needed to express one decimal digit, packing permits more efficient handling of decimal data.

Packed data is taken from main storage, processed, and returned to storage without the data passing through any general registers; this is called *storage-to-storage processing*. The decimal field length, specified by the instruction, can be expanded to as many as 31 digits plus sign, all packed in 16 bytes.

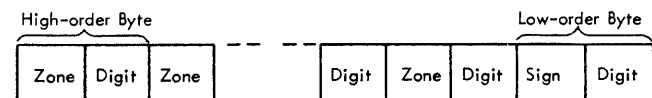

Figure 2-5. Zoned Decimal Number Format

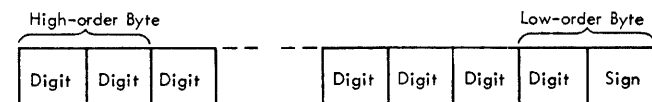

Figure 2-6. Packed Decimal Number Format

Fixed-Point Arithmetic

Fixed-point arithmetic is used to perform arithmetic operations on both data and storage addresses. This combined use permits the fixed-point instructions (as well as several logic instructions) to be used in address computation, permitting shifting and logical manipulation of address components.

The fixed-point binary word, the basic arithmetic operand in System/360, is a 32-bit signed integer (a 31-bit integer with a high-order sign bit). Halfword operands (Figure 2-7) can be specified in many operations where a fullword is not needed, thus improving both performance and storage use.

The 16 general registers, each four bytes (32 bits) wide, are used for fixed-point operations. General registers can also help keep fixed-point product and dividend precision by allowing adjacent registers to be coupled, effectively doubling the register width.

Floating-Point Arithmetic

Floating-point arithmetic, used primarily in scientific applications, greatly increases the speed, precision, and efficiency of computations. In System/360, this form of numeric representation can express positive or negative decimal values from about 10^{-78} to about 10^{76} .

Floating-point numbers may be short (24-bit fractions, with up to seven decimal-place precision), or long (56-bit fractions, with up to 17 decimal-place precision), or extended (112-bit fractions, with about 34-decimal-place precision). Floating-point fractions are made up of hexadecimal (base 16) digits, each consisting of four binary digits and having equivalent decimal (base 10) value of 0-15. The short format usually reduces execution times and increases the number of operands that can be stored; the long format provides greater precision, and the extended format provides about twice the precision of the long format. (See also the "Extended-Precision Floating-Point Feature," discussed in Section 3.)

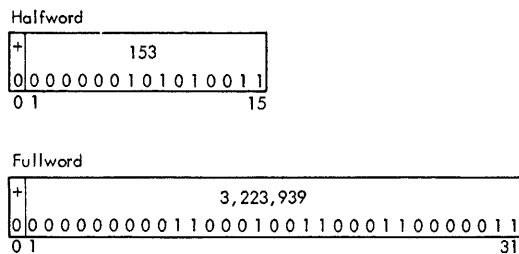

Figure 2-7. Fixed-Point Number Formats (with Signed Binary Data)

Four floating-point registers, each eight bytes wide, are provided. The availability of these registers eliminates much fetching and storing of intermediate results. The 16 general registers are also used, primarily for indexing and address arithmetic.

Logic Operations

The logic operations provide System/360 with the ability to logically manipulate data. The manipulations include: comparing, testing, translating (character for character), editing (sign and punctuation control), and moving logic data. The data may have either a fixed- or variable-length format (Figures 2-8 and 2-9). Fixed-length data, processed through the general registers, may be one, four, or eight bytes long; variable-length data, processed storage-to-storage, can extend to 256 bytes.

Instruction Formats

Main storage addressing and the execution of processing programs are directed by the CPU. The instructions that make up these programs may be of several different formats, identified by the format codes RR, RX, RS, SI, and SS (Figure 2-10).

RR denotes a register-to-register operation. The operands are in general registers and the results replace the first operand.

RX denotes a register-and-storage operation. The first operand is in a general register and the second operand is in a main storage location. This format includes a quantity for indexing the main storage address; the quantity is contained within another general register, which is used as an index register and is specified by the instruction. The results of an RX operation may replace the first operand, depending on the instruction.

RS denotes a register-and-storage operation. The first operand is in a general register, the second operand is in main storage, and a third may be specified by another general register.

Fixed-Length Logic Operand (One, Four, or Eight Bytes)

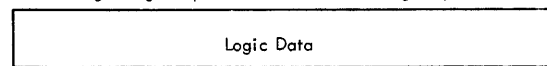

Figure 2-8. Fixed-Length Logic Format

Variable-Length Logic Operand (Up to 256 Bytes)

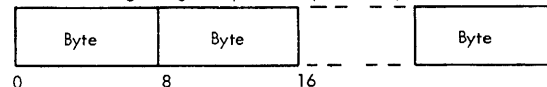

Figure 2-9. Variable-Length Logic Format

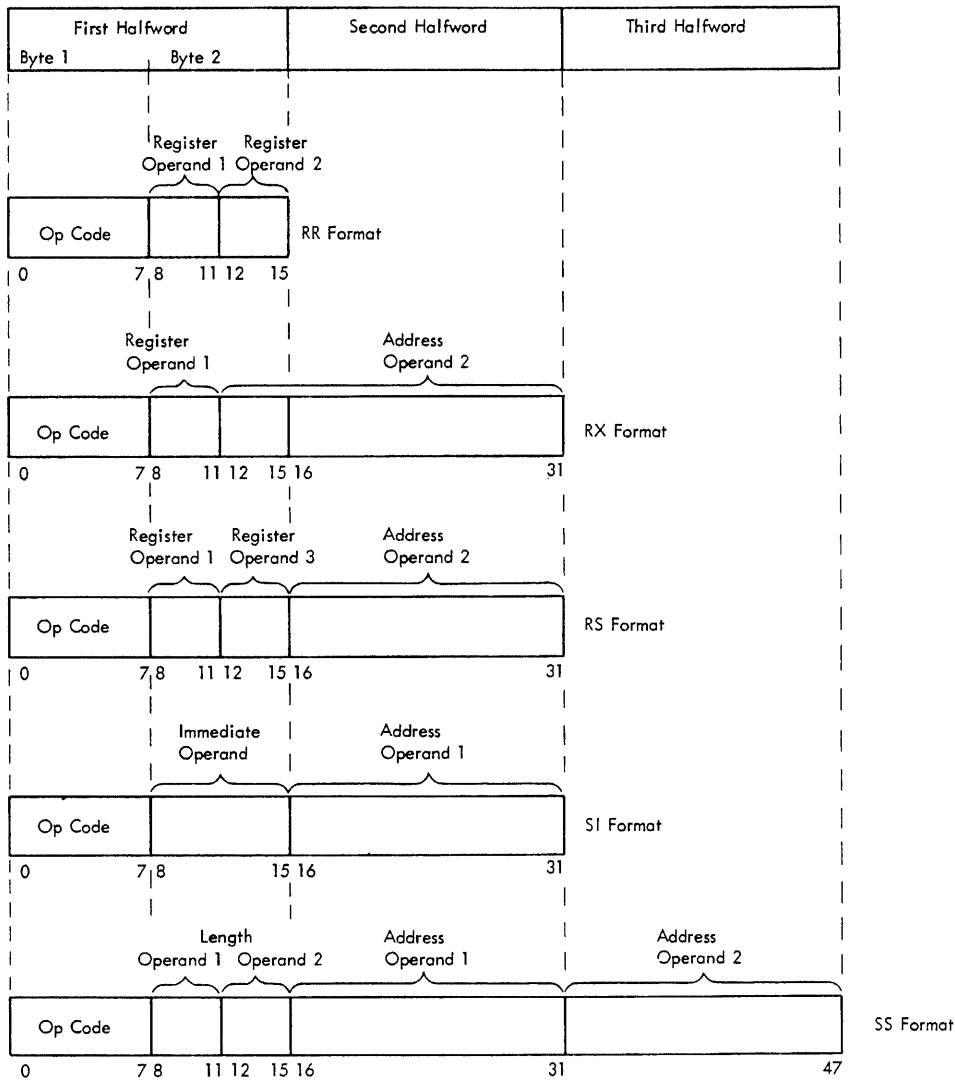

Figure 2-10. Basic Instruction Formats

SI denotes an immediate-operand-and-storage operation. The first operand is one byte of data carried in the instruction itself (the immediate operand), and the second operand is in main storage.

SS denotes a storage-to-storage operation. Both operands are in main storage.

The first byte of each of these formats gives the operation code (the "op code"), which identifies the operation to be performed.

System Control Panel

The control panel, usually mounted on the CPU, provides the operator with manual control of the system. It gives the operator the ability to reset a system, to store and display information, and to load initial program information.

The need for operator manipulation of manual controls is minimized by the system design and by the

governing control program, reducing the number and seriousness of operator errors.

On the larger System '360 models, the operator controls may also be mounted on a stand-alone console, such as the IBM 2150 Console.

Input/Output

An input/output operation transfers data between main storage and an I/O device. An I/O operation is initiated by a program instruction that generates a command to a *channel*. A *control unit* receives the command via the *I/O interface*, decodes it, and starts the I/O device.

Channels

Channels are the direct controllers of I/O devices and control units. They provide System '360 with the ability to read, write, and compute, all at the same time,

by relieving the CPU of the task of communicating directly with the I/O devices.

Channels may be standalone units, complete with the necessary logical and storage capabilities, or they may time-share CPU facilities and be physically integrated with the CPU. The type available to any system model depends on the system model itself. In either case, the channel functions are identical. Channels may be implemented, however, to have different data transfer rates.

Functionally, the channel data path is divided into *subchannels*. To a programmer, each subchannel is treated as a separate channel, and is programmed as such.

Some subchannels can control several I/O devices, whereas others can control only one; these are called *shared* and *nonshared* subchannels, respectively.

System/360 has three major types of channels: byte multiplexer, selector, and block multiplexer.

Byte Multiplexer Channels

Byte multiplexer channels separate the operations of high-speed devices from those of lower-speed devices. Channel operations are in either of two modes: *byte* mode for lower data rates, and *burst* mode for the higher.

In byte mode, the single data path of the channel can be shared by a large number of lower-speed I/O devices (such as card readers, printers, and terminals) operating concurrently; the channel receives and sends data to the I/O devices on demand.

Burst mode is forced by devices such as magnetic tape units, disks, or data cell storage, and is not under the control of the programmer. Such high-speed devices, having established a logical connection with a channel, usually stay connected to it for the duration of data transfer and thereby force the channel into burst-mode state.

The IBM 2870 Multiplexer Channel (Figure 2-11), a standalone unit used with Models 65-195, houses one byte multiplexer channel. Like the in-CPU byte multiplexer channels, the 2870's have *byte multiplexer subchannels*; additionally, 2870's can have *selector subchannels*.

Byte multiplexer subchannels may operate in either byte or burst mode, and may be of either the shared or nonshared type. In byte mode, all subchannels can operate concurrently provided the total load does not exceed channel capacity; each subchannel can operate one low- or medium-speed I/O device. In burst mode, one byte multiplexer subchannel monopolizes the byte multiplexer channel and operates one higher-speed I/O device.

Selector subchannels, which are of the shared type only, operate in burst mode; each can operate one I/O device concurrently with the byte multiplexer subchannels but can control as many as 16 I/O devices.

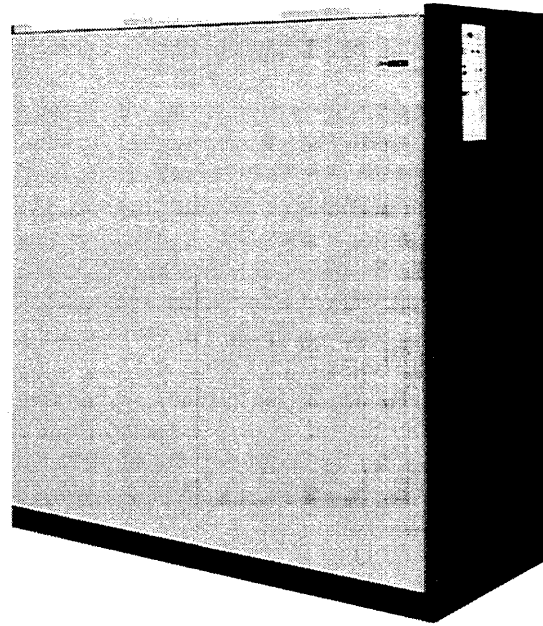

Figure 2-11. IBM 2870 Multiplexer Channel

Selector Channels

Selector channels transmit data to or from a single I/O device at a time. They can handle both high- and lower-speed I/O devices, but their burst-mode operation makes them especially suitable for high-speed devices. Each selector channel attaches up to eight I/O control units and can address as many as 256 I/O devices. One I/O device per selector channel can be transmitting data at any given time; no other I/O device on the channel can transmit data until all data is handled for the selected device.

In general, I/O operations on a selector channel are overlapped with processing, and all channels can operate simultaneously, provided that the processing unit's data rate capabilities are not exceeded. Nominal data rates for the selector channels range from 250 thousand bytes to 1.3 million bytes per second, depending on the system model and the channel options selected.

The IBM 2860 Selector Channel, a standalone unit used with Models 65-195, is similar in appearance to the 2870 Multiplexer Channel, and can house one, two, or three selector channels.

Block Multiplexer Channels

Block multiplexer channels have advantages of both byte multiplexer and selector channels in that they can concurrently operate many high-speed I/O devices on a single data path.

Block multiplexer channels operate in either of two modes: selector or block multiplex. *Selector mode* is

functionally equivalent to selector channel operation, permitting attachment of all the I/O devices which can attach to selector channels. In *block multiplex mode*, these channels permit interleaving (multiplexing) of channel programs for high-speed devices in such a way that channel programs can be initiated sooner and channels can be freed earlier than would be possible with selector channels. The byte and block multiplexer channels differ primarily in that the block multiplexer channels can operate with much faster I/O devices, and they transfer larger quantities of data per transmission. These quantities are referred to as *blocks*, and may include a number of records.

Block multiplexer channels provide a number of subchannels of the shared or nonshared type. The maximum data rates for block multiplexer channels vary with the System/360 models and channel options available, and range up to 3.0 million bytes per second.

The IBM 2880 Block Multiplexer Channel, the standalone unit used with the Model 195, is similar in appearance to the 2870, and houses either one or two block multiplexer channels.

I/O Devices

I/O devices fall into a number of categories, some of which overlap. They are used in and for:

- Auxiliary storage
- Machine and manual (keyed) input, both local and remote
- Teleprocessing
- Reading (or output) of external documents and displays
- Process control
- Data acquisition

Many I/O devices function with an external document, such as a punched card or a reel of magnetic tape. Others handle only electrical signals, such as those in process-control and data acquisition systems.

One of the more common I/O devices in System/360 is the IBM 1052 Printer-Key board, which permits an operator to communicate directly with the system. Usually, the 1052 is located at the CPU; on larger models, it may also be mounted on a stand-alone console.

Control Units

Control units provide the logic circuitry and the storage areas (buffers) needed to operate the attached I/O devices. Yet, to the user, most control unit functions cannot be distinguished from I/O device functions.

A control unit may be single-path, shared-path, or multipath. A single-path unit, usually integrated with an I/O device, controls only one device. Both shared-path and multipath units can control more than one device and are usually stand-alone units. They differ in that a multipath unit permits several I/O devices to transfer data concurrently, whereas the shared-path unit does not.

I/O Interface

This set of lines provides a uniform method of attaching various I/O devices (through control units) to channels, making System/360 adaptable to a wide range of present and future devices and applications. The information format and the control signal sequences provided by the interface are independent of the type of control unit and channel.

Interruption System

The interruption system permits System/360 to operate nonstop and greatly aids the efficient use of I/O equipment. To make the interruption procedure as short and simple as possible, switching between the interrupted program and the control program (the program that services interruptions) must be efficient. This system operates as follows:

The complete status of System/360 is held in an eight-byte *program status word* (psw). This status information, which consists of the instruction address, condition code, storage protection key, etc., is saved when an interruption occurs, and is restored when the interruption has been serviced.

As soon as the interruption occurs, all current status information, together with an identification of the cause of the interruption is put into a psw. This "old" psw is stored at a fixed location. The system then automatically fetches a "new" psw from a different fixed location. Each class of interruption uses two fixed locations in main storage: one to receive the old psw when the interruption occurs, and the other to supply the new psw that governs the servicing of that class of interruption.

After the interruption has been serviced, a single instruction uses the old psw to reset the central processing unit to the status it had before the interruption.

Classes of Interruptions

The interruption system separates interruptions into five classes:

Program interruptions are caused by various kinds of programming errors; the exact type of error is identified in the old psw.

Supervisor Call interruptions are caused when the processing program issues an instruction to pass control to the part of the control program called the *supervisor*, which performs the supervisory functions associated with a task.

External interruptions are caused by an external device that requires attention, by the timer (an internal clocking device) going past zero, or by the operator pressing the interrupt key.

Machine Check interruptions are caused by the machine-checking circuits detecting an error.

I/O interruptions are caused by an I/O unit ending an operation or otherwise needing attention. Identification of the device and channel causing the interruption is stored in the old *PSW*; in addition, the status of the device and channel is stored in a fixed location.

Disallowing of Interruptions

Most interruptions may be either allowed or temporarily disallowed. When an interruption is disallowed, it is either delayed or does not take place, the outcome depending mainly on the class of interruption. The following can be disallowed:

- All I/O interruptions
- All external interruptions
- Some program interruptions
- The machine-check interruption

Specifically, while external and I/O interruptions are disallowed, any external or I/O interruption request is held pending until the interruption is allowed. (An interruption request signal is sometimes called, more briefly, an "interrupt.") While program interruptions are disallowed, the corresponding program interruption request signals are disregarded and do not remain pending. While machine-check interruptions are disallowed, the first machine-check interruption request is held pending until the interruption is allowed, and any

machine-check interrupt beyond that first one is disregarded and does not remain pending.

Priority of Interruptions

During the execution of an instruction, several interruptive events may occur simultaneously. When this occurs, the competing interruption requests are serviced in a fixed order of priority:

- Machine Check
- Program or Supervisor Call
- External
- Input/Output

The program and supervisor-call interruptions are mutually exclusive and cannot occur at the same time.

When more than one interruption requests service, the action consists of storing the old *PSW* and fetching the new *PSW* belonging to the interruption which is taken first. This new *PSW* subsequently is stored without any instruction execution and the next interruption *PSW* is fetched. This process continues until no more interruptions are to be serviced. When the last interruption request has been serviced, instruction execution is resumed using the *PSW* last fetched. The order of execution of the interruption subroutines is, therefore, the reverse of the order in which the *PSW*'s are fetched.

Thus, the most important interruptions — I/O, external, program or supervisor call — are actually serviced first. Machine check, when it occurs, does not allow any other interruptions to be taken.

Section 3. System/360 Features

This section describes the more prominent standard and optional features of System/360. Each feature is discussed under the heading for the system unit with which it is most easily associated.

Some features are standard for some System/360 models and optional for others; and some features are available to only certain models. (See Section 6 for the features available with any specific model.)

Main Storage Features

Main storage includes all directly-addressable storage; that is, both processor storage (which is part of every System/360) and 2361 Core Storage (large-capacity storage), which is an optional feature for several models.

Processor Storage Capacities

Processor storage capacities offer a wide latitude in choosing the amount of storage required. The capacities vary from 16K (16,384) bytes to 4,096K (4,194,304) bytes, depending on the system model. Available models have a choice of storage capacities.

Large-Capacity Storage (LCS), or IBM 2361 Core Storage

The main storage of several larger system models can be increased by adding large-capacity storage (Figure 3-1). The increases are in blocks of either 1,048,576 or 2,097,152 bytes, to a maximum of 8,388,608 bytes. Available capacities are, in round numbers, 1, 2, 4, 6, or 8 million bytes. This storage, located in a separate unit, is addressed contiguously with processor storage. The number of bytes obtained per storage access, the storage protection features, and the other features of LCS (except its 8-microsecond speed) are the same as those of the processor storage of the system to which it is attached.

An advantage of LCS is that it accommodates, in protected storage, large records or vocabularies heretofore located in auxiliary storage media, thereby reducing the number of time-consuming references to I/O devices. Also, LCS can contain large problems, with

extensive reference tables, throughout their execution.

If two-way interleaving is specified for LCS, sequential accesses are alternated between two LCS units and partially overlapped, with the effect, on Models 65 and 75, of increasing the maximum sequential access speed from a rate of 1 megabyte per second (8-microsecond speed with eight bytes per access) to 2 megabytes per second (4-microsecond effective rate). In Model 50, only four bytes are fetched per storage access, and interleaving can be specified only where LCS is to be shared with a Model 65 or 75 in a System/360 multi-system. When interleaving is specified, available LCS capacities are, in round numbers, 2, 4, or 8 million bytes.

Shared Main Storage

Central processing units may share either processor storage or large-capacity storage; the two capabilities are separate. The processor storage associated with two or more central processing units may be shared and addressed by each as a single storage unit. LCS may be shared between two or more systems; the LCS addresses are then an extension of the larger of the two processor storages involved.

Storage Protection

Storage protection, made up of the store and fetch protection features, prevents the unauthorized changing or use of the contents of main storage. *Store protection* prevents the contents of main storage from being altered by storage addressing errors in programs or input from I/O devices. *Fetch protection* prevents the unauthorized fetching of data and instructions from main storage. As many as 15 programs (with associated main storage areas) can be protected at one time.

Protection is achieved by dividing main storage into 2,048-byte blocks and by associating a five-bit *storage key* (Figure 3-2) with each block. Each storage key may be thought of as a lock. Each block of storage, then, has its own "lock." Two instructions are provided for assigning and inspecting the key, which contains a four-bit code. The same code may be used by many blocks, using binary codes 0001-1111.

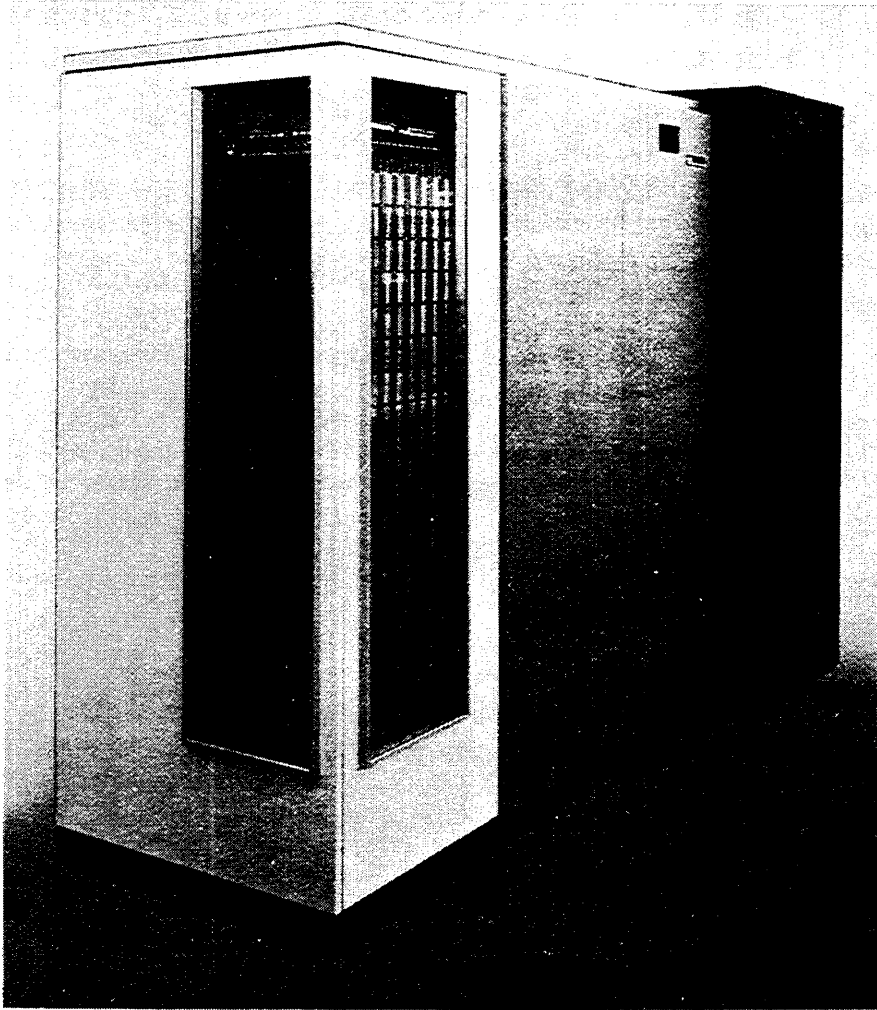

Figure 3-1. IBM 2361 Core Storage (Large-Capacity Storage)

A user's right of access to storage is identified by a four-bit *protection key* (Figure 3-2), located in the program status word (psw) or in a special word used in channel operations. The protection key may be thought of as the key for the "lock". During a main-storage reference (storing or fetching), the storage key is compared with the protection key associated with the reference. Access to the location is granted only when the four leftmost (high-order) bits of the storage key match the protection key, or when the protection key is zero (0000). When both the store and fetch protection features are installed, the right-most (low-order) bit of the storage key determines whether fetch protection is operative for the storage block associated with that key. If the bit is 1, fetch protection is operative; if it is 0, it is inoperative.

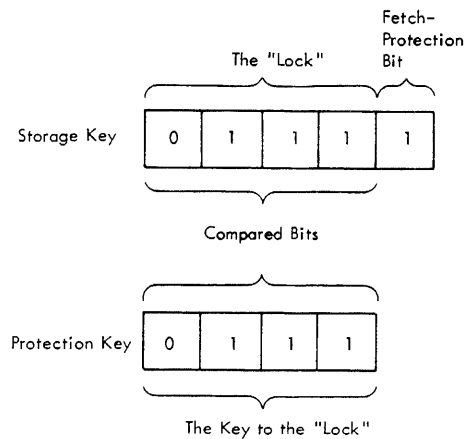

Figure 3-2. Storage and Protection Keys, Showing Matching Keys

Central Processing Unit Features

Instruction Sets

The four major instruction sets available are: *standard*, *scientific*, *commercial*, and *universal*. The instructions that make up the standard instruction set provide System/360 with the basic processing instructions and are included with the other sets (Figure 3-3).

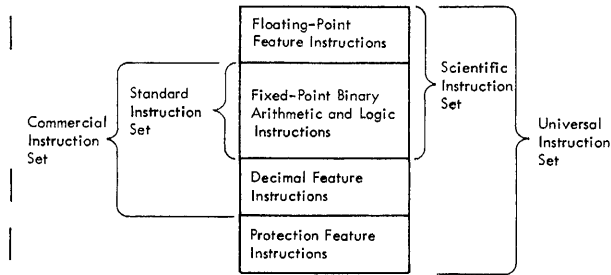

Figure 3-3. System/360 Instruction Sets

Decimal Feature

This feature, especially useful in commercial operations, permits storage-to-storage decimal arithmetic operations and adds two instructions to assist in editing output. The decimal arithmetic instructions, when used with the standard instruction set, make up the commercial instruction set.

Floating-Point Feature

This feature, used primarily in scientific operations, permits calculations on data with a wide range of magnitude. Included with this feature are four 64-bit floating-point registers, which are used to perform these calculations. Operands can be selected for either 24-bit fractions (short precision) or 56-bit fractions (long precision). The floating-point instructions, when combined with the standard instruction set, make up the scientific instruction set.

Extended-Precision Floating-Point Feature

This feature permits floating-point operands to have 112-bit fractions (extended precision) compared to the 56-bit fractions available with long-precision floating-point arithmetic. It also permits results to be rounded from extended to long precision or from long to short precision.

Direct Control and External Interrupt

Direct control provides for exchanging control signals between two System/360 central processing units, or between a System/360 and some specialized device, such as an analog-digital converter.

Direct control bypasses the channel by using the direct-control instructions and six external interruption lines, each of which, when pulsed, sets up the conditions for an external interruption. On some models, the external interrupt feature is available (alone) for users who do not require (or have) the direct-control instructions, but who do require very fast program response to interruptions from time-dependent I/O devices such as the IBM 1419 Magnetic Character Reader and the IBM 1428 Alphameric Character Reader.

Byte-Oriented Operand

The byte-oriented operand feature allows the user to ignore, in part, the restriction that all operands in main storage must be at addresses that are integral multiples of the operand length. The user that takes advantage of this feature can reference fixed-point, floating-point, and logical operands of most *rx*- and *rs*-format instructions on any byte boundary.

The operation performed when the byte-oriented operand feature is used is called *boundary alignment*.

Programming Note: Boundary alignment causes instruction processing to proceed at less than optimal speed. Severe performance degradation may result when boundaries are unaligned.

Dynamic Address Translation

When many users have access to main storage, at any one time, the size of all programs being processed may exceed the capacity of main storage to accommodate them. Dynamic address translation, a combination of advanced programming and circuitry, permits each user to program as though he had sole use of a large, contiguously addressable storage area. On the Model 67, this storage area is about 16 million or 4 billion bytes, depending on whether the standard or the extended dynamic address translation feature is chosen.

Only the active parts of programs reside in main storage; the remaining parts are stored in secondary storage devices. When these parts are called into main storage as needed, they are put in any available location. This procedure is automatic and places no burden on the programmer, who remains unaware that he is not the sole user of the system.

Emergency Power-Off Control

Every System/360 CPU has an emergency power-off switch (on the system control panel), which can remove all electrical potential from all cable-connected units directly controlled by the CPU. Switches for installations with two or more cable-connected CPUs or cable-connected units that can be operated "off-line" (that is, not under direct control of a CPU) are required to be interconnected; this provides, in effect, a single emergency power-off switch. Where units or systems in the same "room" or "area" are not cable-connected, interconnection is strongly recommended.

High-Speed Buffer Storage

This unique feature, integrated with the CPU, can sharply reduce the time required for fetching currently used sections of main storage. On the Model 195, for example, the use of the buffer storage can reduce the *effective* storage access time to about one-fifth of the actual storage access time.

The buffer, though much smaller in capacity than main storage, is quite efficient; most data fetches are made from the buffer rather than from main storage. The buffer achieves high efficiency by using a method of selecting data (for buffer storage) based on the sequential nature of most programs; that is, a storage fetch from some portion of main storage is likely to be followed by other fetches from subsequent locations in that same portion. In a system having buffer storage, such a portion (called a block) is loaded into the buffer, thereby readying the system for fast access to that block. In this way, the buffer is loaded with data most likely to be needed. When the buffer is filled, a fetch from another portion of main storage causes new data to replace the least active block of data in the buffer.

Timers

The timer for System/360 is one of two types: a line frequency timer, or a high-resolution timer. Either type can be used as an interval timer to measure elapsed time, or can be programmed to tell the time of day. With an appropriate program, either timer can be used to measure the duration of a job, poll a communication network at regular intervals (such as every minute or every 15 minutes), and record the time of program completions.

The *line-frequency timer* is counted down every 1/50th or 1/60th of a second, depending on the line frequency. The *high-resolution timer*, however, uses

an oscillator that counts down at much shorter intervals (for example, every 13 microseconds on the Model 67).

An external interruption occurs automatically when time runs out, unless it is disallowed. The full duration for either timer, from the maximum stored value to the time when the interruption signal is generated, is 15.5 hours.

Time Sharing

Time sharing permits many users at remote terminals to use a system as if each were its only user. The computer may actually be switching among many terminals and processing many programs, giving each terminal a small slice of its available time. Time sharing is especially applicable to scientific and engineering problems, where:

1. The computations are not usually of a repetitive nature.
2. It is advantageous to enter a problem piecemeal into the computer and observe intermediate results before proceeding with the computation.

The Model 67 can provide apparently simultaneous operations to various users at remote terminals. It can operate in this time-sharing mode 24 hours a day and process batch jobs during the time available between calls from remote terminals for computing.

Channel Features

Channel-to-Channel Adapter

This adapter provides a path for data transfers between two channels and synchronizes such transfers, providing systems with interchannel communication.

The channels may be either within the same system or on separate systems. Within one system, an adapter can permit the moving of blocks of data from one area in main storage to another. Connecting a channel of one system to a channel of another has the effect of interconnecting two CPUs.

The adapter uses one control-unit position on each of the two connected channels, but only one channel need have the adapter.

System Features

Compatibility Features for Other IBM Systems

A number of features are available that permit operation of certain models of System/360 by the use of programs written for other IBM systems. These compatibility features are combinations of circuitry and programming that make the System/360 able to read

programs written for the other system and to function like that system. In many cases, the program runs much faster on System/360 than on the system for which it was written.

Compatibility features are also called *emulators*, but not simulators. The latter, although they may perform the same function, do so with programming alone and thus run slower.

A compatibility feature is particularly useful when the user needs time to convert his present programs to System/360 code but, at the same time, wants the advantages offered by System/360. In addition, using such a feature may eliminate the need for converting programs that are seldom used.

Sufficient storage and appropriate or equivalent I/O devices must be available for the use of a compatibility feature. Furthermore, the use of one compatibility feature usually precludes the use of another. Under unusual conditions, a feature may not be able to maintain exact compatibility; for example, programs that are time-dependent may not yield identical results, and the handling of error conditions may differ.

In Figure 6-9 is a list of the compatibility features presently available and of the models of System/360 in which they may be incorporated if minimum and matching configuration requirements are met.

System Partitioning (Duplex Model 67-2)

A Model 67-2 with two CPU's may be partitioned into two independently operated systems. This can be achieved by programs that refer exclusively to certain components, but it is more desirable to partition components from the rest of the system by means of centrally located controls.

Such means are provided by the IBM 2167 Configuration Unit, a console-like component on which the partitioning switches and indicators are located. Partitioning from the required 2167 provides for operation of two-CPU systems as one multisystem (basic) or as independent systems. If one or more components become inoperative, partitioning permits them to be bypassed for continuing service.

Section 4. System/360 Programming Systems

The System/360 programming support supplied by IBM is aimed at minimizing the time and effort required by the user to produce and process programs. Programming support ranges from relatively simple programs to highly sophisticated operating systems. It falls in three categories:

- Basic Programming Support
- Special Systems Support
- Operating Systems

Basic Programming Support (BPS)

The BPS programs provide support for minimum card and tape configurations. BPS furnishes a large number of independent programs, each performing its specific functions, and provides translators for the following programming languages:

- Assembler
- Report Program Generator (RPG)
- FORTRAN

BPS also includes utility programs (e.g., write tape to cards, write disk to tape), sort/merge programs, and Autotest (a program testing and modifying facility). Other BPS programs support applications for optical and magnetic character readers.

Most BPS programs require only 8K bytes of main storage ($K = 1,024$).

Special Systems Support

Model 44, a scientific and engineering system, and Model 67, a time-sharing system, have special programming support consistent with the particular applications of these systems. (Support for these models is discussed briefly in Section 6.)

Operating Systems—General Facts

An operating system is a collection of programs that provides for the preparation and execution of the user's problem programs (jobs). IBM-supplied operating systems are designed to match the needs of the equipment configuration and the customer's job requirements.

All operating systems are either tape-resident or direct-access-resident and consist of two basic parts:

- Control program
- Processing programs

Control Program

The control program is the framework of an operating system; it has three distinct functions:

- Job management
- Task management (Supervisor)
- Data management

Job Management provides the facilities to read, interpret, initiate, and terminate jobs submitted for processing. It also provides the facilities for the operator to communicate with the system.

Task Management is the core of an operating system. Because it performs the supervisory functions associated with the execution of a task, it is often called the supervisor. The functions provided generally include interruption handling, resource allocation, fetching of non-resident routines, time supervision, and transient-error recovery.

Data Management provides the functions of record blocking and deblocking, space allocation on direct access devices, processing of labels, and the transfer of data between main storage and external devices, all by means of various *access methods*. These functions allow data sets (sometimes called data files) and their processing the utmost independence from the I/O environment. The access methods used are well-defined and consistent ways of handling data sets according to their basic organization: sequential, indexed sequential, direct, partitioned, etc. Some access methods provide automatic buffering facilities.

Processing Program

A processing program is defined as any program that is not a control program. Processing programs are kept on tape or direct access devices, as collections of data sets known as libraries, and fall in three general categories:

- Language Translators* for Assembler, FORTRAN, COBOL, PL/I, etc.

- Service Programs* such as utilities and sort/merge.

- User-Written Problem Programs* that become part of the operating system library and are retrievable by name alone.

Specific Operating Systems

The operating systems supplied by IBM have been designed in modular fashion so that functions may be incorporated according to the need of the user and the size of his equipment configuration. The operating system is created and integrated with the equipment at the time of installation during an operation called *system generation*.

The four IBM-supplied operating systems for the System/360 are:

System/360 Basic Operating System (BOS)
System/360 Disk Operating System (DOS)
System/360 Tape Operating System (TOS)
System/360 Operating System (OS)

BOS

BOS is resident on IBM 2311 Disk Storage in a System/360 with at least 8K bytes of main storage. In addition to a control program, BOS includes Assembler and RPG language translators, utilities, a disk sort/merge program, and Autotest.

DOS/TOS

DOS/TOS are 2311 or 2314 disk-resident and 2400-series tape-resident, respectively, in a system having at least 16K bytes of main storage; however, to realize the full potential of either DOS or TOS, at least 32K bytes is recommended. These operating systems offer additional functions commensurate with progressively larger systems; they also provide facilities for multiprogramming and (with DOS) teleprocessing. Each provides a control program, five language translators (for Assembler, RPG, FORTRAN, COBOL, and PL/I), utilities, sort/merge programs, Autotest, and special-purpose librarian programs—including those for the maintenance of and printed/punched output from libraries. TOS provides a multiprogramming facility that permits the concurrent execution of two or three programs, DOS also permits multiprogramming, and provides communications functions through Basic Telecommunications Access Method (BTAM).

OS

OS is the most sophisticated and the most powerful of the operating systems. It is designed for use on most System/360 models. It may be used on Model 67, but only when the special time-sharing system for that model is not in use. With the sacrifice of a few functions—perhaps not needed for a particular installation—OS can be integrated in a system having as little as 32K of main storage. To take advantage of most options, however, at least 64K bytes is required; the storage size must be estimated for each system or multisystem according to the OS facilities actually needed. OS is resident on direct access devices having

a data rate that the using model of System/360 is capable of accepting. OS offers three control programs:

Primary Control Program (PCP)
Multiprogramming with a Fixed Number of Tasks (MFT)
Multiprogramming with a Variable Number of Tasks (MVT)

PCP is the base on which all control programs are built. It schedules and executes job steps one at a time. When generating a programming system, functional capabilities may be selected in a variety of combinations and added to those included in PCP to produce additional capabilities.

MFT reduces the problem of CPU wait-time by supervising the execution of more than one job at a time. Each job is executed in its own area of main storage. The size of each of these areas, or *partitions*, is established when the system is generated, but may be changed by the operator. MFT is especially useful to users who must process a wide variety of jobs that require a corresponding variety of computing system resources. The system's capability of providing partitions as small as 8K bytes is a distinct advantage to the user with many small jobs.

MVT also supervises execution of more than one job step at a time, but in addition, allocates main storage dynamically to each job. This configuration supports the large job customer as well as the customer who has many small jobs. Regions for MVT can be as small as 12K bytes.

Before MVT can schedule a job, the programmer must request, through a control language, the amount of main storage required and the devices required. Because a single job will probably not require all of main storage nor all devices, the remaining resources can be given to other jobs. The programmer also has some control over the sequence of job scheduling. Instead of scheduling jobs in the order in which they are submitted, MVT schedules jobs according to specified priorities.

When more than one job is being executed at the same time, each job competes for the machine and program resources it needs. The main factor in resolving the competition for machine resources is the scheduling priority of the job. When two jobs are being executed, the job with the higher priority uses the CPU when needed.

MVT extends the idea of priorities beyond between-job competition for resources to competition within jobs; i.e., different priorities can be given to separate tasks of a job step.

The minimum storage capacities are 64K bytes for PCP, 128K bytes for MFT, and 256K bytes for MVT.

The facilities of BOS, DOS, and TOS are depicted in Figure 4-1. A diagram of OS is available on a card in color; see *Operating System/360 Chart*, GV25-6156.

Programming Systems Glossary

*Assemble**. To prepare a machine language program from a symbolic language program by substituting absolute operation codes for symbolic operation codes and absolute or relocatable addresses for symbolic addresses.

*Assembler**. A program that assembles.

*Compile**. To prepare a machine language program from a computer program written in another programming language by making use of the overall logic structure of the program, or generating more than one machine instruction for each symbolic statement, or both, as well as performing the function of an assembler.

*Compiler**. A program that compiles.

*Initial Program Loader (IPL)**. The procedure that causes the initial part of an operating system or other program to be loaded such that the program can then proceed under its own control.

IOCS. Input/Output Control System.

*Linkage**. In programming, coding that connects two separately coded routines.

Linkage Editor. A program that produces a load module by: (1) transforming object modules into a format that is acceptable for execution, (2) combining separately produced object modules and previously processed load modules into a single load module, (3) resolving symbolic cross references among them, (4) replacing, deleting, and adding control sections automatically on request, and (5) providing overlay facilities for modules requesting them.

Load Module. (1) The output of the linkage editor. (2) A program in a format suitable for loading into main storage for execution.

*Macro Instruction**. An instruction in a source language that is equivalent to a specified sequence of machine instructions.

*Module**. A program unit that is discrete and identifiable with respect to compiling, combining with other units, and loading; for example, the input to, or output from, an assembler, compiler, or linkage editor.

*Object Module**. A module that is the output of an assembler or compiler and is input to a linkage editor.

*Program Library**. A collection of available computer programs and routines.

* American National Standard definition

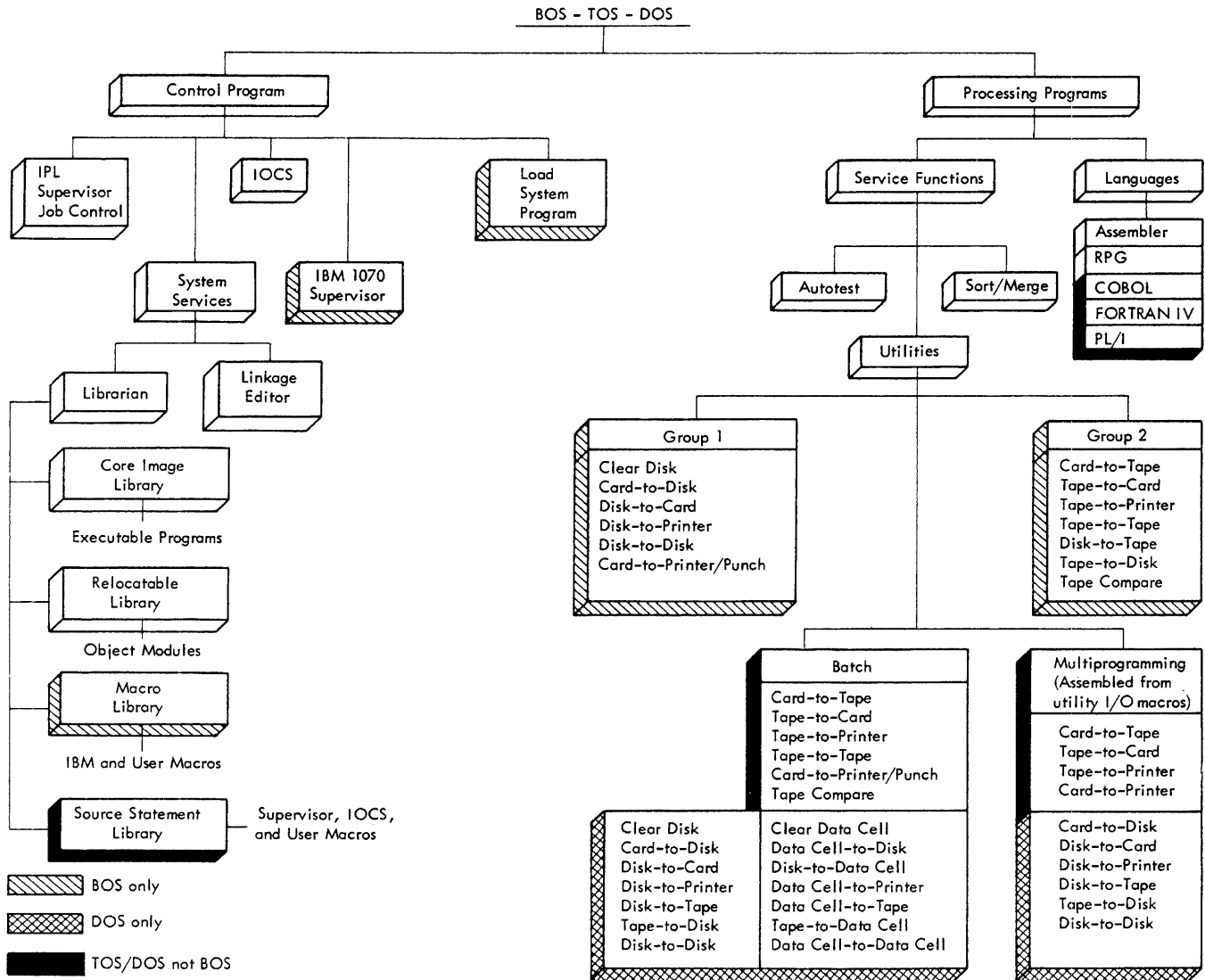

Figure 4-1. Facilities of BOS, TOS, and DOS

Section 5. Teleprocessing, Data Acquisition, and Process Control

Teleprocessing

One of the major considerations in designing System/360 was that the system would have to serve as the data processing complex within a larger teleprocessing system. (Figure 5-1)

IBM's past experience with real-time and teleprocessing systems indicated that there are two major differences between teleprocessing systems and the more familiar batch processing systems: batch processing input is scheduled, whereas teleprocessing input is unscheduled; batch processing is usually serial, whereas teleprocessing is random. To incorporate the ability to service these two teleprocessing characteristics into a system that would probably be used mostly for batch processing, the System/360 designers had to create new equipment and new programming conventions.

As an example of how a teleprocessing system functions, suppose that a clerk in an insurance company's branch office receives a telephone call asking for in-

formation about an insured's account. Asking the caller to hold the line, the clerk enters the information request into a terminal, and the request is sent over a communications line to the System/360 at the insurance company's main office. When the request reaches the computer, several things happen. The computer interrupts processing whatever job it is working on (perhaps the payroll is being run) and saves all necessary data and instructions so that it can resume processing at exactly the point in the program it had reached before it was interrupted. As the information is received over the communications lines, the communications module in the control program converts the data into machine language, stores it in a buffer area, and checks to see that it was transmitted correctly.

The nature of the request may dictate that a number of different operations must be performed. To process the request, the teleprocessing program directs the System/360 to run through the appropriate policy file

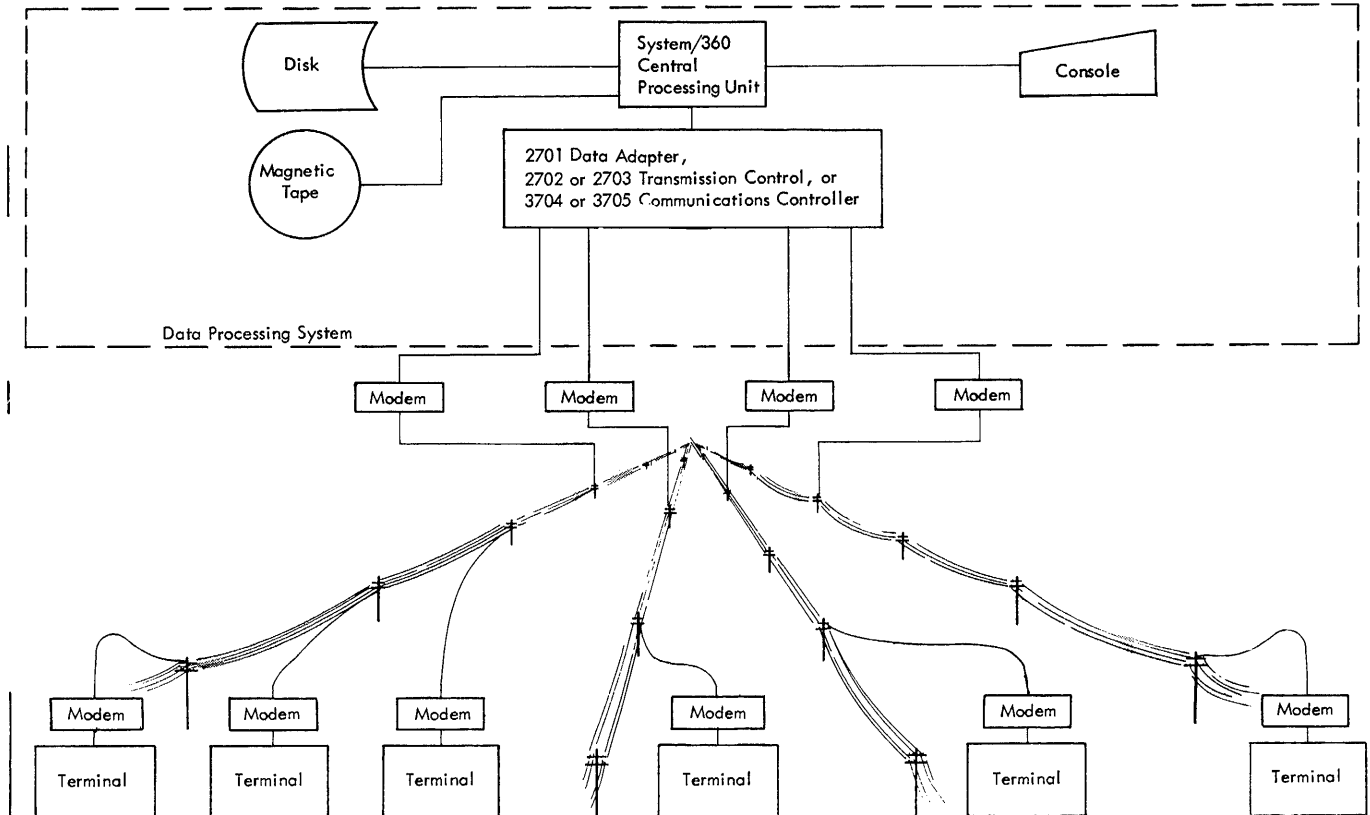

Figure 5-1. System/360 as a Teleprocessing System

and bring the insured's record from storage. The program then searches the record for the information requested and sends it out over the communications lines to the clerk who originated the request. The clerk reads the information as it is typed out at his terminal and relays the information to the policyholder or adjuster waiting on the telephone. Back at the main office, the control program has returned the System/360 to its status prior to the interruption by the inquiry, and the computer has resumed processing the payroll program.

Requirements of a Teleprocessing System

A careful examination of the preceding example reveals that any teleprocessing system must meet certain requirements. System/360 was designed to respond to all of these requirements without sacrificing its efficient performance of the ordinary batch data processing needs of science and industry.

Transmission Control Capability

The system may be servicing many locations, some on common communications lines and some on separate lines. Equipment and programming are therefore required to handle the multiple inputs arriving in unscheduled fashion into the System/360.

Program Switching

On a single transaction, the control program initiates several switches among the various programs; therefore, the processing unit must be designed to accomplish very rapid program switching.

Program Relocation

The processing unit must also have the ability to dynamically relocate programs in storage during normal processing, because many different types of transactions may necessitate bringing a program from peripheral storage into a location in main storage for which the program was not originally assembled.

Storage Protection

With multiple programs residing in the system at one time and with constant program switching and relocation taking place, it is imperative that there be a facility available that can prevent one program from changing another program's instructions and data.

Transmission Directions and Modes

A communications line (also called a communications channel or circuit) is a path for electrical transmission between two or more terminals. Basically, IBM equipment can operate over three types of circuits: simplex, half-duplex, and duplex (also called full duplex). These circuit names describe only directional capability.

Simplex Circuits can carry data in only one direction.

Half-Duplex Circuits can carry data in two directions but in only one direction at a time.

Duplex Circuits can carry data in two directions at the same time.

A network can consist of any combination of these circuits according to application requirements.

Modes

Information can be transmitted over the various types and grades of circuits by three different modes of transmission:

1. *Asynchronous Transmission* (also called serial start/stop) requires the use of start and stop bits to designate the beginning and ending of characters.
2. *Synchronous Transmission* eliminates the need for start and stop bits; a special pattern of bits is sent periodically to keep the transmitter and receiver operating in unison. The bit pattern is generated automatically and sent as required by the system.
3. *Parallel Transmission* allows all bits of a character to be transmitted simultaneously by providing one circuit for each bit in the code structure.

Most often a user obtains his communications lines from a communications common carrier. The common carrier leases him a private line for his exclusive use or connects him with the telephone network available to the public. A user can also purchase and maintain his own communications facilities, but these must be purchased from suppliers other than common carriers. There are numerous government regulations concerning the connection of privately owned communications facilities to those owned and maintained by common carriers.

Terminal Connections to Communications Lines

In this System Summary the word "terminal" refers to a machine or group of machines capable of generating and/or receiving signals transmitted over a communications line. Within this definition a terminal may range from a data processing system, such as System/360, to a single device, such as an IBM 2740 Communication Terminal. One terminal may be connected to another by a point-to-point line or by a multipoint line. A *point-to-point* (common carrier leased or private) line connects a single terminal to another single terminal, whereas a *multipoint* line connects more than two terminals. On circuits with little traffic, the use of a multipoint line often results in a cost saving. Terminals sharing the same line may or may not have the ability to communicate with each other.

Modems

A modem, also called a data set or line adapter, performs the modulation and demodulation functions necessary to provide compatibility between business machines and communications facilities. Modulation is the conversion of digital signals (from the business machine) to audio-frequency signals for transmission over communication lines. Demodulation reconverts the information for machine use.

Modems may be furnished by communications common carriers, equipment suppliers, or by IBM. Those available as features for some devices are called IBM line adapters.

One modem is required at each interface between the communications facilities and the data processing equipment.

Data Acquisition and Process Control

A high-speed data acquisition system is designed to maintain constant communication with a process for such purposes as:

1. Determining whether the process is operating within acceptable limits.
2. Providing records for accounting or management decisions.
3. Providing a record of data obtained during a research experiment.

A process control system usually incorporates data acquisition facilities and has the additional capability of using the acquired data as a basis for supervising and controlling the process.

Section 6. System/360 Models

The various models and input/output configurations within the System/360 cover a wide range of commercial and scientific data-handling requirements. Presently, nine models of the System/360 are covered in the System Summary: Models 22, 25, 30, 40, 50, 65, 67, 75, and 195. In this section, the more prominent features and characteristics of each model are brought together to describe each model individually. Figure 6-9, which compares each model's prominent features and characteristics with those of the other models, appears at the end of this section. The devices that can attach to the individual System/360 models are listed in the next two sections.

System/360 Model 22

The System/360 Model 22 (Figure 6-1) has the power and capabilities to meet a wide variety of scientific and

commercial needs at a relatively low cost. Provided either 24K (24,576) bytes or 32K (32,768) bytes of main storage, this model has a selector channel and byte multiplexer channel that allow the attachment of a wide variety of I/O devices. Other features, both standard and optional, further enhance the capabilities of the Model 22.

Standard Features

- Standard or commercial instruction set
- Byte multiplexer channel
- Selector channel

Optional Features

- Scientific or universal instruction set
- External interrupt
- Interval timer
- Storage protection
- Integrated 1052 attachment

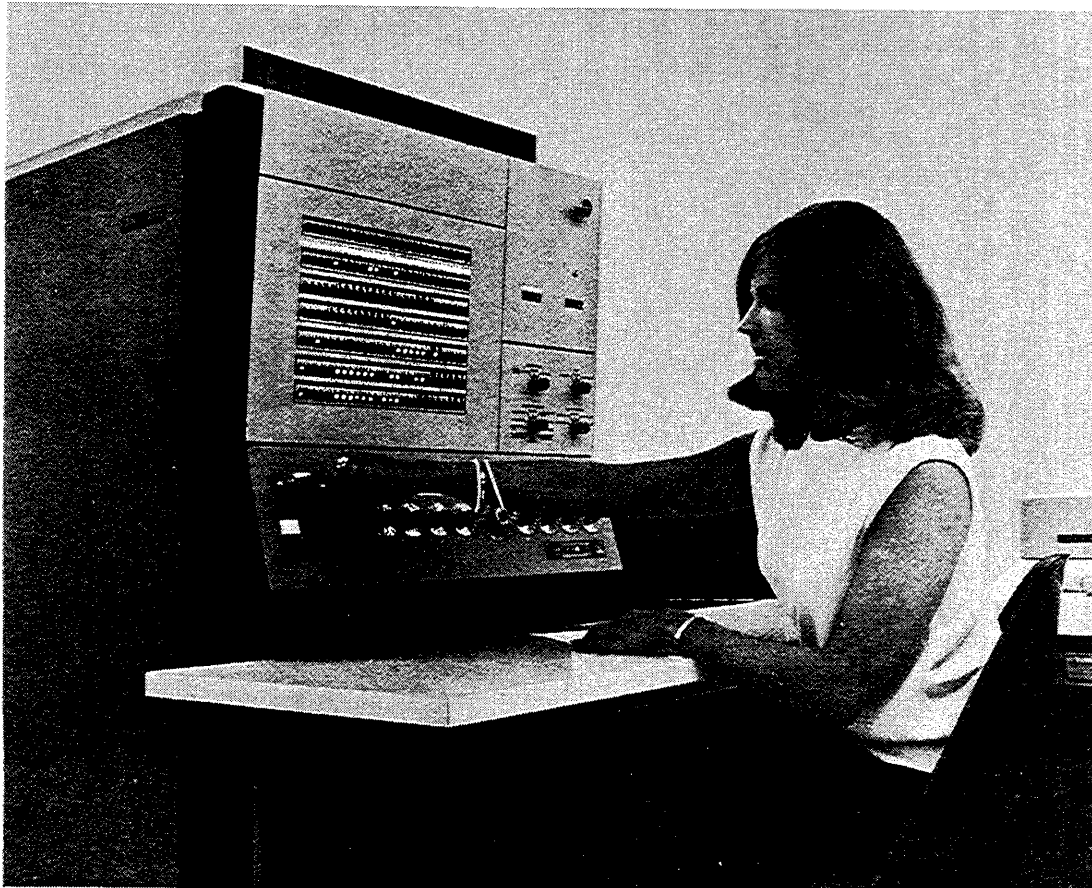

Figure 6-1. IBM System/360 Model 22

System Components

Central Processing Unit: IBM 2022 Processing Unit

Basic Machine Cycle Time: 0.75 microsecond (750 nanoseconds).

Instruction Sets: Either the standard or commercial instruction set is provided with the Model 22. Either set can be replaced by the scientific or universal set.

External Interruption: The external interrupt feature provides six external interruption lines for requesting a response from the Model 22 and for identifying the request.

Main Storage: Part of 2022 Processing Unit

Storage Sizes:

CAPACITY (BYTES)	MODEL
24,576	DC
32,768	E

Storage Cycle Time: 1.5 microseconds.

Storage Access Width: One byte.

Channels: Part of 2022 Processing Unit

Byte Multiplexer Channel: The byte multiplexer channel provides 96 subchannels and eight control-unit positions.

Selector Channel: The selector channel, which has a data rate of 170,000 bytes per second, uses a microprogram interruption to control data transfers.

Interchannel Connection: The Model 22 can communicate with other models of System/360 by the direct connection of channels, but only if the other model has a channel-to-channel adapter. The adapter requires the use of one control-unit position on each of the two channels.

Programming Support

DOS is the primary programming support for the Model 22. Other existing System/360 applications and programming systems support can be used by the Model 22 within the limitations of storage capacity, channel capability, and CPU features.

System/360 Model 25

Delivering System/360 performance at relatively low cost, the System/360 Model 25 (Figure 6-2) offers features such as main storage capacities of up to 49,152 bytes, channel capabilities, decimal and floating-point arithmetic, and compatibility with the System/360 Model 20 and the IBM 1401, 1440, and 1460 Data Processing Systems.

High performance at minimal cost has been achieved in several ways: by the inclusion of high-speed circuitry for main storage, by the use of microprogramming for emulator and control routines, and by the integrated attachment of the most commonly used I/O devices, in which the normally separate control units are incorporated in the CPU.

Standard Features

Commercial instruction set
Attachment for 1052 Printer-Keyboard Model 7

Optional Features

Scientific or universal instruction set
Byte multiplexer channel or selector channel (one of either)
Store protection
Direct control (with external interrupt) or external interrupt (alone)
Timer (line-frequency type)
1401/1460 compatibility
1401/1440/1460 DOS compatibility
1440 compatibility
System/360 Model 20 mode

CPU-integrated attachments for:

- One 1403 Printer Model 2, 7, or N1 (with multiple character set adapter)
- As many as four 2311 Disk Storage Drives Model 1 (with file scan feature)
- One 2540 Card Read Punch Model 1 (with column binary feature and punch feed read control)
- One 2560 Multi-function Card Machine Model A1 (for Model 20 mode; also for System/360 mode [read/punch only] if the 2540 emulation feature is added)
- CPU-integrated communications attachment

System Components

Central Processing Unit: IBM 2025 Processing Unit

Basic Machine Cycle Time: 0.90 microsecond (900 nanoseconds).

Instruction Set: The commercial instruction set is provided with the Model 25. This set can be replaced by the optional scientific or universal instruction set.

Control Signal Exchange and External Interruption: The direct control feature is optional; it includes the external interrupt feature.

CPU-Integrated I/O Attachment: The CPU provides for the integrated attachment of a 1052 Printer-Key-board Model 7 and the following I/O devices: one 1403 Printer Model 2, 7, or N1, as many as four of the 2311 Disk Storage Drive Model 1, one 2540 Card Read Punch Model 1, and one 2560 Multi-function Card Machine Model A1. Each of these devices can connect

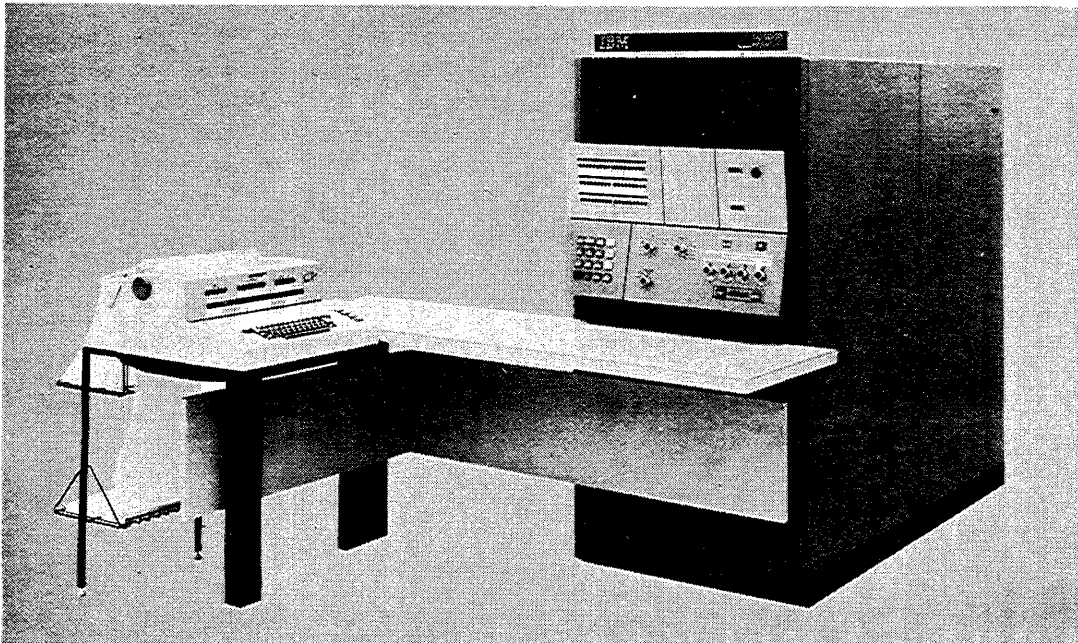

Figure 6-2. IBM System/360 Model 25 with 1052 Printer-Keyboard

to the CPU by means of an appropriate attachment feature and does not require a control unit (2821 or 2841) physically attached to an I/O channel, although to the program the device appears to be on a channel and is addressed accordingly.

In addition to the integrated units, a wide range of other I/O devices is available for attachment to the Model 25 through the use of either a byte multiplexer or selector channel (both optional). For further details, see Figure 7-1.

CPU-Integrated Communications Attachment: This feature provides teleprocessing entry for Model 25 users through direct attachment of communications lines to a Model 25 rather than through a 2701 Data Adapter Unit or 2702 Transmission Control on a byte multiplexer channel. (See Figure 8-1.)

Main Storage: Part of 2025 Processing Unit

Storage Sizes: The Model 25 has four possible storage sizes:

CAPACITY (BYTES)	MODEL
16,384	D
24,576	DC
32,768	E
49,152	ED

Storage Cycle Time: 1.8 microseconds (1,800 nanoseconds). Storage cycle time is the length of time that storage is busy when a reference is made to it.

Storage Access Width: Two bytes (one halfword).

Protection Features: Store protection is optional.

Channels: Part of 2025 Processing Unit

Byte Multiplexer Channel: When the byte multiplexer channel is operated in byte mode, the I/O devices can operate concurrently with each other, with the integrated devices, and with CPU operations. In burst mode,

I/O devices can overlap their operations with those of integrated devices but not with CPU operations. With the Model 25, magnetic tape units cannot be used on the byte multiplexer channel.

Selector Channel: This channel can overlap integrated-device and CPU operations and has a maximum data transfer rate of 60,000 bytes per second. The selector channels of Model 25's built prior to February, 1969 have a maximum data rate of 30,000 bytes per second, but will be modified to have the higher data rate.

Interchannel Connection: The Model 25 can communicate with other System/360 models by the direct connection of channels, but only if the other model has a channel-to-channel adapter. The adapter requires the use of one control-unit position on each of the two channels.

System

Compatibility Features: The features that can be installed on the Model 25 are: 1401/1460 compatibility, 1440 compatibility, 1401/1440/1460 dos compatibility, disk storage operations (for processing 1311 disk information), and System/360 Model 20 mode. The 1401/1440/1460 dos compatibility feature cannot be installed if the Model 25 has either the scientific instruction set or the integrated communications attachment.

System Control: The Model 25 is operated, monitored, and controlled via the system control panel on the 2025 Processing Unit.

Programming Support

The Model 25 can use System/360 application and programming systems support. Existing bps, bos, tos, and dos programs apply to the Model 25, within the limitations of the storage capacity and channel capabilities.

System/360 Model 30

The System/360 Model 30 (Figure 6-3) offers versatility with economy for both scientific and commercial applications. On this model, a wide choice of storage capacities (exceeding those of the Model 25), inter-channel connection, 1400-series and 1620 compatibility features, and channel attachments for a large number and variety of I/O devices are available.

The storage capacities of the Model 30 range from 16,384 to 65,536 bytes, offering users the opportunity to closely match storage to their needs. The byte multiplexer channel, a standard feature, provides as many as 224 subchannels and permits the attachment of as many I/O devices.

The versatility of the Model 30 can be increased by adding a channel-to-channel adapter, which permits this model to operate as either a peripheral system or an independent one. As a peripheral system, it can handle functions for a larger System/360 model, freeing it for other tasks; these functions include the smoothing of peak-load scheduling, the handling of system overflow, and system backup.

Also on the Model 30, users of the IBM 1401, 1440, 1460, and 1620 Data Processing Systems can run unconverted programs; under most circumstances, these programs can be run both faster and more economically.

Standard Features

- Standard instruction set
- Byte multiplexer channel

Optional Features

- Commercial, scientific, or universal instruction set
- Timer (line-frequency type)
- Store protection
- Selector channels. (as many as two)
- Additional byte multiplexer subchannels (total of 224)
- Direct control (with external interrupt) or external interrupt (alone)
- 1401/1440/1460 compatibility or 1620 compatibility
- Channel-to-channel adapter
- Attachment for 1052 Control Unit

System Components

Central Processing Unit: IBM 2030 Processing Unit

Basic Machine Cycle Time: 0.75 microsecond (750 nanoseconds).

Instruction Set: The standard instruction set is provided with the Model 30. This set can be replaced by the optional commercial, scientific, or universal instruction set.

Control Signal Exchange and External Interruption: The direct control feature is optional; it includes the external interrupt feature. The external interrupt feature (available separately) provides six distinct external interrupt lines for requesting a response from the Model 30 and for identifying the request.

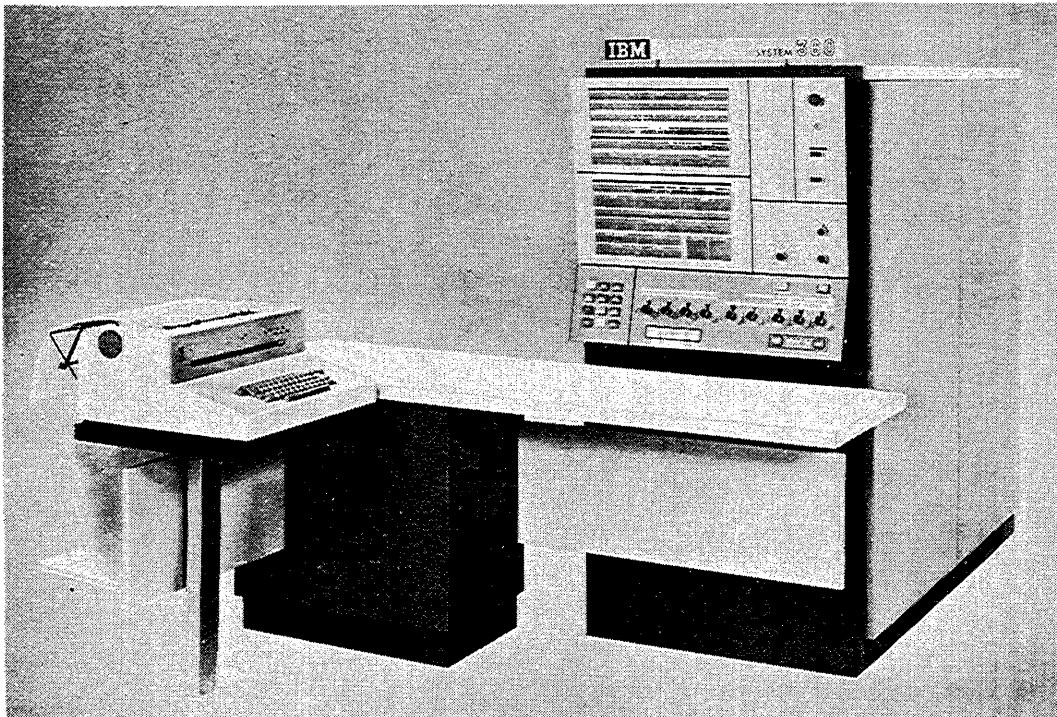

Figure 6-3. IBM System/360 Model 30 with 1052 Printer-Keyboard

Main Storage: Part of 2030 Processing Unit

Storage Sizes:

CAPACITY (BYTES)	MODEL
16,384	D
24,576	DC
32,768	E
65,536	F

Storage Cycle Time: 1.5 microseconds (2.0 on earlier models).

Storage Access Width: One byte.

Protection Features: Store protection is optional; fetch protection is not a feature for the Model 30.

Channels: Part of 2030 Processing Unit

One byte multiplexer channel is standard on the Model 30, and one to two selector channels are optional. The number of byte multiplexer subchannels varies from 96 to as many as 224 (with the additional byte multiplexer subchannels feature).

BYTE MULTIPLEXER SUBCHANNELS	MODELS
96	All
224 (optional)	E, F

Interchannel Connection: One channel-to-channel adapter may be installed on either a byte multiplexer or a selector channel, permitting communication between two channels (on the same system or on different systems). One control-unit position is required on each of the connected channels. A second channel connection can be made with another system if an adapter is installed on the other system.

System

Compatibility Features:

COMPATIBILITY FEATURE	APPLICABLE MODELS
1401/1440/1460 DOS	All but D
1401/1460	All
1440	All
1620	All

Installation of one compatibility feature precludes installation of another.

System Control: The Model 30 is operated, monitored, and controlled via the system control panel on the 2030 Processing Unit.

Programming Support

The Model 30 is supported by BPS, BOS, DOS, TOS, and by OS with PCP.

System/360 Model 40

The System/360 Model 40 (Figure 6-4) has the power and capabilities to meet a wide variety of scientific and commercial needs. Its main storage capacity (from 32,768 to 262,144 bytes) is, at its maximum, four times larger than the main storage capacity of the Model 30. Its attachable I/O devices include the 2303 Drum Storage, providing nearly four million bytes of direct-access storage with a maximum data transfer rate of 303,800 bytes per second. The Model 40 also offers compatibility features to users of the IBM 1401, 1410, 1440, 1460, and 7010 Data Processing Systems that permit them to run unconverted programs on the Model 40 with generally increased speed and efficiency.

Standard Features

Standard instruction set
 Byte multiplexer channel
 Timer (line-frequency type)

Optional Features

Commercial, scientific, or universal instruction set
 Store protection
 Selector channels (as many as two)
 Channel-to-channel adapter
 Direct control (includes external interrupt)

1401/1460 compatibility
 1401/1440/1460 DOS compatibility
 1410/7010 compatibility
 Adapter for 1052 Printer-Keyboard Model 7

System Components

Central Processing Unit: IBM 2040 Processing Unit

Basic Machine Cycle Time: 0.625 microsecond (625 nanoseconds).

Instruction Set: The standard instruction set is provided with the Model 40. This set can be replaced by the optional commercial, scientific, or universal instruction set.

Control Signal Exchange and External Interruption: The direct control feature is optional; it includes the external interrupt feature.

Main Storage: Part of 2040 Processing Unit

Storage Sizes:

CAPACITY (BYTES)	MODEL
32,768	E
64,536	F
131,072	G
196,608	GF
262,144	H



Figure 6-4. IBM System/360 Model 40

Storage Cycle Time: 2.5 microseconds.

Storage Access Width: Two bytes (one halfword).

Protection Features: Store protection is optional; fetch protection is not a feature for the Model 40.

Channels: Part of 2040 Processing Unit

One byte multiplexer channel is standard on the Model 40, and one to two selector channels are optional. Between 32 and 128 byte multiplexer subchannels are available, depending on which model is used.

BYTE MULTIPLEXER SUBCHANNELS	MODELS
32	E
64	F
128	G,GF,H

Interchannel Connection: One channel-to-channel adapter may be installed on a selector channel and attached to either a byte multiplexer or selector channel. It permits communication between channels (on the same system or on different systems). The adapter requires one control-unit

position on each of the connected channels. A second channel connection can be made with another system if an adapter is installed on the other system.

System

Compatibility Features:

COMPATIBILITY FEATURE	APPLICABLE MODELS
1401/1460	All
1401/1440/1460 DOS	All
1401/1440/1460 Relocatable DOS	All but E
1410/7010	All but E

System Control: The Model 40 is operated, monitored, and controlled via the system control panel on the 2040 Processing Unit.

Programming Support

The Model 40 is supported by BPS, BOS, DOS, TOS, and OS.

System/360 Model 50

The System/360 Model 50 (Figure 6-5) offers a performance significantly greater than that offered by the Model 22, 25, 30, or 40. Its advantages include: increased storage speed and access width, the overlapping of channel and CPU activities, added channel options, more main storage, and the use of an optional 2361 Core Storage (referred to as Large-Capacity Storage or LCS).

Storage: The maximum storage capacity of the Model 50 is 524,288 bytes. This storage can be expanded with LCS by 1, 2, 4, 6, or 8 million bytes (in rounded figures).

Speed: The Model 50's four-byte storage access width and 2.0-microsecond storage cycle time make this model much faster in its internal processing speed than either the Model 30 or 40. Also, the overlapping of byte multiplexer channel and CPU operations further increases the speed of system operations.

The channel options permit increased speed and versatility in I/O operations. The use of one to three selector channels permits the operation of an equal number of high-speed I/O devices, and the number of subchannels of the byte multiplexer channel can be increased to operate as many as 256 lower-speed devices.

Compatibility: Compatibility features on the Model 50 allow users of the IBM 1410, 7010, 7070, and 7074 Data Processing Systems to run current jobs directly on the Model 50 without reprogramming, often with increased speed.

Standard Features

- Universal instruction set
- Store protection
- Byte multiplexer channel
- Timer (line-frequency type)

Optional Features

- 2361 Core Storage (LCS) with attachment
- Shared LCS
- Selector channels (as many as three)
- Additional byte multiplexer subchannels (total of 256)
- Channel-to-channel adapter
- Direct control (includes external interrupt)
- 1410/7010 or 7070/7074 compatibility
- Adapter for 1052 Printer-KeyBoard Model 7

System Components

Central Processing Unit: IBM 2050 Processing Unit

Basic Machine Cycle Time: 0.5 microsecond (500 nanoseconds).

Instruction Set: The universal instruction set is a standard feature of the Model 50.

Control Signal Interchange and External Interruption: The direct control feature (with the external interrupt feature included) is optional.

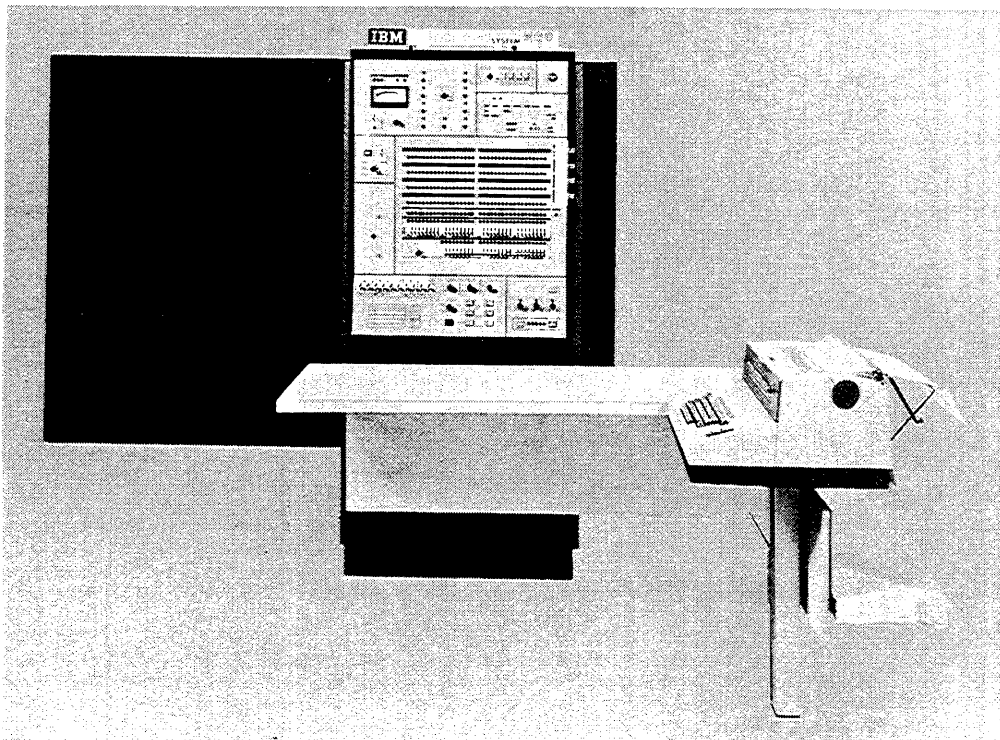

Figure 6-5. IBM System/360 Model 50 with 1052 Printer-KeyBoard

Main Storage: Part of 2050 Processing Unit; IBM 2361 Core Storage Models 1 and 2 (Optional)

Storage Sizes:

CAPACITY (BYTES)	MODEL
131,072	G
262,144	H
393,216	HG
524,288	I

Storage Cycle Time: 2.0 microseconds.

Storage Access Width: Four bytes (one word).

Protection Features: Store protection is standard; fetch protection is not a feature for the Model 50.

Large-Capacity Storage: The following units of 2361 Core Storage may be used: one 2361-1 without interleaving but two with it; one to four 2361-2's without interleaving but two or four with it.

Channels: Part of 2050 Processing Unit

One byte multiplexer channel is standard, and one to three selector channels are optional. The byte multiplexer channel has 128 or 256 subchannels (with the additional byte multiplexer subchannels feature).

BYTE MULTIPLEXER SUBCHANNELS	MODELS
128	All
256 (optional)	All but G

Interchannel Connection: One channel-to-channel adapter may be installed on either a byte multiplexer or selector channel, permitting communication between channels (on the same system or on different systems). The adapter requires one control-unit position on each of the connected channels. A second channel connection can be made with another system if an adapter is installed on the other system.

System

Compatibility Features:

COMPATIBILITY FEATURE	APPLICABLE MODELS
1410/7010	All
7070/7074	All but G

Installation of one feature precludes installation of the other.

System Control: The Model 50 is operated, monitored, and controlled via the system control panel on the 2050 Processing Unit. The operator control section of this panel may be duplicated to provide a remote operator control panel and can be mounted on a 2150 Console or a 2250 Display Unit Model 1.

Programming Support

The Model 50 is supported by BPS, BOS, DOS, TOS, and OS.

System/360 Model 65

The System/360 Model 65 (Figure 6-6) offers powerful performance with exceptional versatility in large-system applications. This is achieved primarily with large storage capacity, high speed, compatibility with a large number of systems, and multiprocessing system capabilities.

The Model 65 has a maximum main storage capacity of 1,024K (1,048,576) bytes in a single-CPU Model 65, and with additional features, 2,048K (2,097,152) bytes in the two-CPU Model 65 Multiprocessing System. The storage of a single-CPU system can be supplemented by 1,024K to 8,192K (8,388,608) bytes with 2361 Core Storage (LCS). LCS permits access to large blocks of data without the need for time-consuming references to I/O devices, resulting in both increased capacity and speed.

The Model 65's storage accessing, significantly larger and faster than the Model 50's, also increases the speed of operations. Two-way interleaving further increases the speed of operations by substantially reducing the effective access time.

With the configuration-control panel feature, the multiprocessing (Model 65 MP) system can be formed from two Model 65's operating as a single large-scale system under one control program. The CPU's of each Model 65 are interconnected, and both main storage and the I/O devices are shared. Such a system offers several advantages:

1. It balances the workload among the CPU's, main storage units, and the I/O devices to provide more efficient use of these units. Thus the combined system can operate at close to its top theoretical efficiency, adjusting its full resources at any time to match the workload of each CPU.
2. It increases critical system availability, especially desirable in real-time applications. By the use of the configuration control panel, units can be removed from operation and the system reconfigured without them. Also, programs are available that provide error correction capabilities, further increasing system availability.
3. It provides exceptional flexibility. The system can allow each of the two Model 65's to operate as an independent subsystem, each with its own control program and its assigned main storage and I/O devices.

Standard Features

Universal instruction set
Storage protection (both store and fetch protection)
Attachment for 2870 Multiplexer Channel
Attachment for 2860 Selector Channel
Timer (line-frequency type)

Optional Features

2361 Core Storage (LCS) with attachment (not available for Model 65 Multiprocessing System)
Shared LCS (not available for Model 65 Multiprocessing System)
2860 Selector Channel (providing as many as six selector channels per CPU)
2870 Multiplexer Channel (as many as two per CPU)
Selector subchannels (as many as four on the first 2870, as many as two on a second one)
Channel-to-channel adapter
Direct control (includes external interrupt)
7070/7074, 7080, or 709/7040/7044/7090/7094 II compatibility
Adapter for 1052 Printer-Keyboard Model 7 (as many as two)
Configuration control panel

System Components

Central Processing Unit: IBM 2065 Processing Unit

Basic Machine Cycle Time: 0.2 microsecond (200 nanoseconds).

Instruction Set: The universal instruction set is standard with the Model 65.

Control Signal Exchange and External Interruption: The direct control feature is available as an option and includes the external interrupt feature.

Main Storage: IBM 2365 Processor Storage Models 2 and 13; IBM 2361 Core Storage Models 1 and 2 (Optional)

Storage Sizes:

CAPACITY (BYTES)	MODEL	STORAGE UNITS
262,144	H	One 2365-2
524,288	I, MP	Two 2365-2's or -13's
786,432	IH, MP	Three 2365-2's or -13's
1,048,576	J, MP	Four 2365-2's or -13's
1,310,720	MP	Five 2365-13's
1,572,864	MP	Six 2365-13's
1,835,008	MP	Seven 2365-13's
2,097,152	MP	Eight 2365-13's

The Model 65 MP uses 2365-13's, whereas the single-CPU Model 65 uses 2365-2's. The 2365-2's can be field-converted to 2365-13's.

Storage Cycle Time: 0.75 microsecond.

Storage Access Width: Eight bytes (one dblwd).

Storage Interleaving: Two-way.

Protection Features: Both store and fetch protection are standard features.

Large-Capacity Storage (2361 Core Storage):

	NUMBER OF 2361-1's	NUMBER OF 2361-2's
Without interleaving	1	1 to 4*
With interleaving	2	2 to 4*

*If the system has two 2860's and two 2870's, then the maximum number of 2361's permitted is three rather than four.

Channels: IBM 2860 Selector Channel Models 1-3 and 2870 Multiplexer Channel

The Model 65 can have as many as seven channels per CPU (one byte multiplexer and six selector or two byte multiplexer and five selector) but requires at least one.

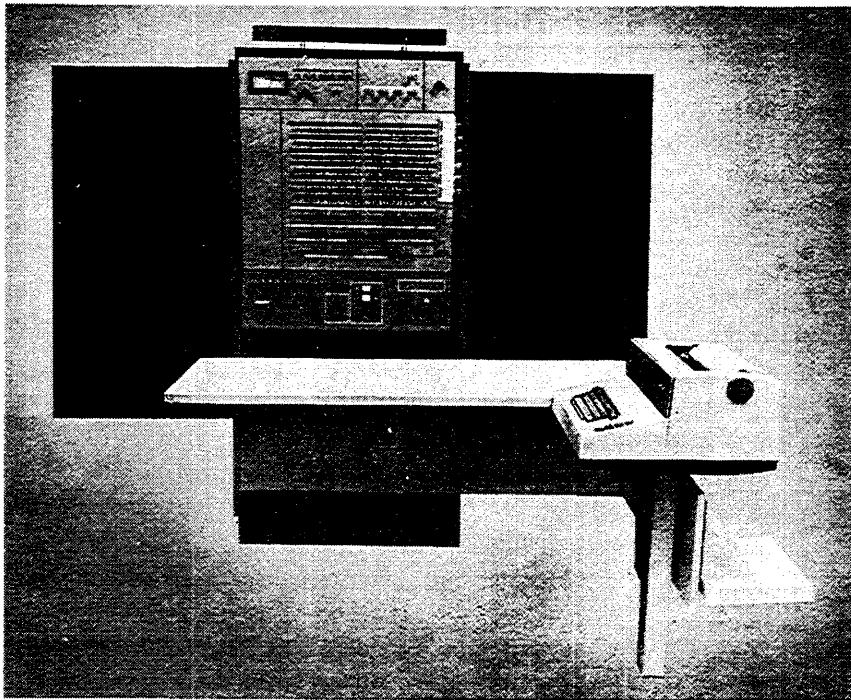

Figure 6-6. IBM System/360 Model 65 with 1052 Printer-Keyboards

The 2870 Multiplexer Channel provides the Model 65 with subchannels:

	BYTE MULTIPLEXER SUBCHANNELS	SELECTOR SUBCHANNELS (OPTIONAL)
First 2870	192	up to 4
Second 2870	192	up to 2*

*None on any second 2870 of a Model 65 MP.

Interchannel Connection: The channel-to-channel adapter is used to interconnect two System/360 channels. On the Model 65, an adapter can be attached for each of the selector channels, permitting each of them to communicate with either a byte multiplexer channel or with another selector channel. The use of an adapter requires one control-unit position on each of the connected channels.

System

Multiprocessing System: The two CPU's of the Model 65 Multiprocessing System share the 2365-13 storage units. Prerequisites of this system are emergency power-off control (on one CPU), the direct control feature, and the configuration control panel.

Compatibility Features:

COMPATIBILITY FEATURE	APPLICABLE MODELS
7070/7074	All
7080	All
709/7040/7044/7094/7094 II	All but H

Only one of these compatibility features (emulators) can be installed on any Model 65 system. For emulation on a Model 65 MP, the required portions of the system must be partitioned out of the system environment; that is, the CPU with the compatibility feature,

the appropriate amount of storage, and the required I/O units must be partitioned as a separate system.

System Control: The Model 65 is operated, monitored, and controlled via the system control panel on the 2065 Processing Unit. A remote operator control panel is also available, which can duplicate the operator control section of the system control panel and may be mounted on a 2150 Console or a 2250 Display Unit Model 1. The Model 65 MP has, in addition, a configurator control panel which is shared by the two CPU's and which provides for switching among three modes (multisystem, partitioned, and Model 65), manually assigning storage addresses, and switching I/O interfaces on- or off-line.

Programming Support

The Model 65 is supported by BPS, BOS, DOS, TOS, and OS.

For the control program of OS, the Model 65 uses the Primary Control Program (PCP), Multiprogramming with a Fixed Number of Tasks (MFT), or Multiprogramming with a Variable Number of Tasks (MVT). These are discussed in Section 4. With MVT or MFT, the Model 65 has Recovery Management Support (RMS) programs; they provide the Model 65 with error-correction capabilities, and thereby minimize the impact of machine malfunctions.

The Model 65 Multiprocessing System is an integral part of OS with MVT. Any job that operates with MVT can be processed in the multiprocessing system without changing code, job control language, or data.

System/360 Model 67

Designed primarily for time-sharing applications, the System/360 Model 67 is a unique combination of equipment and advanced programming which provides fast access to this high-performance system from remote terminals.

This model has two basic configurations: the Model 67-1 and the Model 67-2 (Figure 6-7). The Model 67-1 is a one-CPU system with a 2067 Processing Unit Model 1; the Model 67-2 may be a one-CPU (half-duplex) or a two-CPU (duplex) system with one or two 2067-2's, a 2167 Configuration Unit, and a 2846 Channel Controller.

In addition to its time-sharing capability, the Model 67 can economically and efficiently handle huge libraries of data, can be partitioned into separate subsystems for specific jobs, and can work around temporarily disabled components without disturbing critical jobs. These advantages are due in part to the following features and characteristics.

Shared Storage: The duplex Model 67-2 allows shared use of the multiple processor storage units by the two CPU's, making available as many as two million bytes of storage to either unit.

System Partitioning: The duplex model also allows partitioning of the components into separate subsystems for maximum flexibility and availability, achiev-

ing this by controls provided on the IBM 2167 Configuration Unit.

Dynamic Address Translation: This combination of advanced programming and circuitry permits each user to program as though he had sole use of a large, contiguously-addressable main storage area of about 16 million or 4 billion bytes, depending on whether the standard or the extended dynamic address translation feature is chosen. This feature may be turned off to permit use of the Model 67 as a Model 65.

Standard Features, Model 67-1

- Universal instruction set
- Seven-bit storage protect (for the 2067 Processor Unit Model 1)
- Attachment for as many as two 2860 Selector Channels
- Attachment for one 2870 Multiplexer Channel
- 24-bit dynamic address translation
- Timer (high-resolution type)

Standard Features, Model 67-2

- Universal instruction set
- Address prefixing (for the 2067 Processing Unit Model 2)
- Attachment for the first 2067-2 (for the 2365-12)
- Shared storage
- Floating storage addressing (for the 2167 Configuration Unit)
- Floating channel addressing (for the 2167 Configuration Unit)
- Seven-bit storage protect (for the 2067-2)
- Attachment for as many as two 2067 Processing Units Model 2
- Attachment for as many as eight units of 2365 Processor Storage Model 12 (for the 2846)
- Attachment for a 2846 Channel Controller (one per 2067-2)
- 24-bit dynamic address translation
- Partitioning sensing (for the 2167 Configuration Unit)
- Timer (high-resolution type)



Figure 6-7. IBM System/360 Model 67-2 Duplex Configuration

Optional Features, Model 67-1

Floating storage addressing
High-speed, direct-access storage priority (for the first selector channel)
Expansion feature (for 2365 Processor Storage Model 2)
Seven-bit storage protect (for the 2365 Processor Storage Model 2)
2860 Selector Channel (providing as many as six selector channels)
2870 Multiplexer Channel (as many as two)
Selector subchannels (as many as four on the first 2870, as many as two on a second one)
Channel-to-channel adapter
Direct control (includes external interrupt)
709/7040/7044/7090/7094/7094 II compatibility
Extended dynamic address translation
Adapter for 1052 Printer-KeyBoard Model 7

Optional Features, Model 67-2

Address prefixing (one for each channel on the duplex Model 67-2)
Additional addressing, types I and II (for each 2846 Channel Controller)
High-speed, direct-access storage priority (used only on the first selector channel)
2846 switching feature (as many as two)
Expansion feature
Power sequencing
2067 switching feature
2860 Selector Channel (as many as two units per 2846)
2870 Multiplexer Channel (one per 2846)
Selector subchannels (as many as four)
Channel-to-channel adapter
Additional attachment for the 2846 Channel Controller
Extended direct control (includes external interrupt)
709/7040/7044/7090/7094/7094 II compatibility
Partitioning sensing (for the 2067 Processing Unit Model 2)
Extended dynamic address translation
Adapter for the 1052 Printer-KeyBoard Model 7
Second wall section attachment

System Components

Central Processing Unit: IBM 2067 Processing Unit Models 1 and 2

One 2067-1 is available with the Model 67-1, but one to two 2067-2's are available with the Model 67-2.

Basic Machine Cycle Time: 0.2 microsecond (200 nanoseconds).

Instruction Set: The universal instruction set is standard with the Model 67.

Control Signal Exchange and External Interruption: The direct control feature is optional on the Model 67-1, and the extended direct control feature, which permits the direct communication of control information between two CPU's, is used on the duplex Model 67-2. Each CPU in a duplex system must be equipped with this feature. Both control features include the external interrupt feature.

Dynamic Address Translation: This combination of advanced programming and circuitry permits each user to program as though he had sole use of a large, contiguously-addressable main storage area of about 16 million or 4 billion bytes, depending on whether the

standard or the extended dynamic address translation feature is chosen.

Partitioning Sensing: This feature, required on each CPU of a duplex Model 67-2, allows the program to sense the status of all partitioning switches of the 2167 Configuration Unit.

Floating Storage Addressing: This feature provides the Model 67-1 with the capability of changing the addressing of 2365 Processor Storage Model 2's.

Main Storage: IBM 2365 Processor Storage Models 2 and 12

As many as four 2365-2's are available with the Model 67-1 and as many as eight 2365-12's with the Model 67-2.

Storage Sizes:

CAPACITY (BYTES)	MODEL
262,144	67-1, 67-2
524,288	67-1, 67-2
786,432	67-1, 67-2
1,048,576	67-1, 67-2
1,310,720	67-2
1,572,864	67-2
1,835,008	67-2
2,097,152	67-2

Storage Cycle Time: 0.75 microsecond.

Storage Access Width: Eight bytes (one dblwd).

Storage Interleaving: Two-way.

Protection Features: The seven-bit storage protect feature expands the standard fetch protection to accommodate the dynamic address translation feature. One such protection feature is required on each 2365-2; it is standard on the 2365-12.

Shared Storage: The duplex Model 67-2 allows shared use of the multiple processor storage units by the two CPU's, making as many as 2,097,152 bytes of storage available to either unit.

IBM 2167 Configuration Unit

The 2167 Configuration Unit contains:

1. The partitioning switches and lights for the 2067 Processing Unit Model 2's, 2365 Processor Storage Model 12's and 2846 Channel Controllers.
2. The switches for the I/O control units.

Included also are the floating addressing controls (for both channels and storage) and the partitioning sensing feature.

IBM 2846 Channel Controller

This unit (used only with the Model 67-2) provides the system with increased accessibility to auxiliary storage devices, especially useful in time-sharing applications. In the duplex Model 67-2, it provides:

1. Communication between the CPU's and the channels controlling the auxiliary storage devices.
2. Data paths for control information and data transfers between main storage and the channels.

The basic 2846 allows for the attachment of as many as four units of 2365 Processor Storage Model 12; the additional addressing features (I and II) increase this number to eight, permitting the 2846 to address over 2 million bytes of main storage. Also, as many as two 2846's may be attached to a Model 67-2 permitting as many as 14 channels (12 selector and 2 byte multiplexer) in a system.

Channels: IBM 2860 Selector Channel Models 1-3 and 2870 Multiplexer Channel

The Model 67 can have as many as seven channels per CPU (six selector and one byte multiplexer, or alternatively for the Model 67-1, five selector and two byte multiplexer) but requires at least one channel of either type.

The 2870 Multiplexer Channel provides the Model 67 with subchannels:

	BYTE MULTIPLEXER SUBCHANNELS	SELECTOR SUBCHANNELS (OPTIONAL)
First 2870	192	up to four
Second 2870 (on 67-1 only)	192	up to two

With the Model 67-2, one 2846 Channel Controller attachment feature is standard, and a second is optional. Each 2846 can attach one 2870 and two 2860's; at least one 2860 or 2870 is required. Therefore, with two 2846's, two byte multiplexer channels can be available; only one of these channels may have more than eight control units or have selector subchannels. The duplex Model 67-2 also requires the address prefixing feature on each channel.

Interchannel Connections: The channel-to-channel adapter is used to interconnect two System/360 channels. On the Model 67, an adapter can be attached for each of

the selector channels, permitting each of them to communicate with either a byte multiplexer channel or with another selector channel. The use of an adapter requires one control-unit position on each of the connected channels.

System

Compatibility Feature: The 709/7040/7044/7090/7094/7094 II compatibility feature may be installed on both the Model 67-1 and the Model 67-2.

System Control: The Model 67 has one system control panel per CPU. Each one provides for the operation, monitoring, and control of the CPU on which it is mounted. A remote operator control panel is also available for each CPU, and each panel duplicates the CPU-mounted operator controls and may be mounted on a 2150 Console.

Programming Support

The Model 67 can operate in either a standard mode under DOS, ROS, or OS, or a time-sharing mode under the Time-Sharing System (TSS). While operating under TSS, the Model 67 is capable of doing conversational-interactive computing together with batch processing on a time-shared basis. TSS takes advantage of the capabilities of a multiprocessor system and performs dynamic relocation of problem programs by using the dynamic address translation facilities of the 2067 Processing Unit. (See "Dynamic Address Translation" discussed previously in this model description.)

In the conversational-interactive mode, TSS uses a 2741 Communication Terminal as a remote terminal for such operations as one-line program development and testing, problem solving, and data entry and display.

System/360 Model 75

The System/360 Model 75 (Figure 6-8) is a significant step higher in efficiency and speed of internal processing than the Model 65. The primary advantages of the Model 75 are: shorter instruction execution times (approximately two times shorter than the Model 65) and overlapping of processing (two instructions processed concurrently). The Model 75 has a maximum main storage capacity of 1,048,576 bytes, which can be supplemented by an additional one to eight million bytes of 2361 Core Storage (LCS). The effective speed of storage access is increased by the use of two- and four-way interleaving (two-way only for LCS).

Standard Features

- Universal instruction set
- Storage protection (both store and fetch protection)
- Attachment for 2870 Multiplexer Channel
- Attachment for 2860 Selector Channel
- Direct control (includes external interrupt)
- Timer (line-frequency type)

Optional Features

- 2361 Core Storage (LCS) with attachment
- Shared LCS
- 2860 Selector Channel (providing as many as six selector channels)
- 2870 Multiplexer Channel (as many as two)
- Selector subchannels (as many as four on the first 2870, as many as two on a second one)
- Adapter for 1052 Printer-Keyboards Model 7 (as many as two)

System Components

Central Processing Unit: IBM 2075 Processing Unit

Basic Machine Cycle Time: 0.195 microsecond (195 nanoseconds).

Instruction Set: The universal instruction set is standard with the Model 75.

Control Signal Exchange and External Interruption: The direct control feature is standard on the Model 75 and includes the external interrupt feature.

Main Storage: IBM 2365 Processor Storage Model 3; IBM 2361 Core Storage Models 1 and 2 (Optional)

Storage Sizes:

CAPACITY (BYTES)	MODFL	STORAGE UNITS	TYPE OF INTERLEAVING
262,144	H	One 2365-3	Two-way
524,288	I	Two 2365-3's	Four-way
786,432	IH	Three 2365-3's	Two-way
1,048,576	J	Four 2365-3's	Four-way

Storage Cycle Time: 0.75 microsecond.

Storage Access Width: Eight bytes (one double-word).

Protection Features: Both store and fetch protection are standard on the Model 75.

Large-Capacity Storage (2361 Core Storage):

	NUMBER OF 2361-1's	NUMBER OF 2361-2's
Without interleaving	1	1 to 4*
With interleaving	2	2 to 4*

*If the system has two 2860's and two 2870's, the maximum number of 2361's permitted is three rather than four.



Figure 6-8. IBM System/360 Model 75 with IBM 2150 Console

Channels: IBM 2860 Selector Channel Models 1-3 and 2870 Multiplexer Channel

The Model 75 can have as many as seven channels (six selector and one byte multiplexer, or five selector and two byte multiplexer) but requires at least one.

The 2870 Multiplexer Channel provides the Model 75 with subchannels:

	BYTE MULTIPLEXER SUBCHANNELS	SELECTOR SUBCHANNELS (OPTIONAL)
First 2870	192	up to 4
Second 2870	192	up to 2

Interchannel Connection: The channel-to-channel adapter is used to interconnect two System/360 channels. On the Model 75, an adapter can be attached for each of the selector channels, permitting each to communicate with

either a byte multiplexer channel or with another selector channel. The use of an adapter requires one control-unit position on each of the connected channels.

System

System Control: The Model 75 is operated, monitored, and controlled via the system control panel on the 2075 Processing Unit. A remote operator control panel is also available which can duplicate the operator control section of the system control panel and may be mounted on a 2150 Console or a 2250 Display Unit Model 1.

Programming Support

The Model 75 is supported by BPS, BOS, DOS, TOS, and OS.

System/360 Model 195

The System/360 Model 195 is an ultrahigh-performance data processing system designed for high-speed large-scale scientific and commercial applications. Its scientific applications range from nuclear physics to weather forecasting and theoretical astronomy. In commercial applications, the Model 195 can be used, for example, as the control center of the most complex airline reservation systems, coast-to-coast time-sharing networks, or process control systems.

The power and speed of this advanced system are primarily the result of:

1. Improved circuit technology.
2. High performance of buffer storage for main storage accesses.
3. Buffering within the processor.
4. Very fast execution times.
5. A high degree of concurrency in operation.
6. Highly efficient algorithms, particularly in floating-point operations.

Circuitry: The logic circuits in the Model 195 use monolithic technology. These advanced circuits have a basic delay time of less than 5 nanoseconds, as compared with delay times of 5 to 30 nanoseconds for SLT circuits used in most other System/360 models. Also, the monolithic packaging densities are many times those of SLT circuitry; boards approximately 8 by 12 inches contain as many as 4,000 circuits.

Parallel Processing: Processing proceeds concurrently in five separate highly autonomous units: main storage, the storage control unit and buffer storage, the instruction processor, the fixed-point/variable-field-length/decimal processor, and the floating-point processor. Furthermore, each unit may be performing several functions at one time. In the floating-point processor, for example, as many as three floating-point operations may be executed concurrently.

Standard Features

- Universal instruction set
- High-speed buffer storage
- Extended-precision floating-point
- Byte-oriented operands
- Storage protection (both store and fetch protection)
- Attachment for 2860 Selector Channel
- Attachment for 2870 Multiplexer Channel
- Attachment for 2880 Block Multiplexer Channel
- Direct control (includes external interrupt)
- Interval timer (9.6 kHz—about a 104-microsecond interval)
- System console
- Remote operator control panel attachment
- Emergency power-off control

Optional Features

- 2860 Selector Channel (providing as many as six selector channels)
- 2870 Multiplexer Channel (as many as two)
- Selector subchannels (as many as four on the first 2870, as many as two on a second one)
- 2880 Block Multiplexer Channel (providing as many as six block multiplexer channels per CPU)
- Channel-to-channel adapter
- 2150 Remote Operator Console

System Components

Central Processing Unit: 3195 Processing Unit

Basic Machine Cycle Time: 0.054 microsecond (54 nanoseconds).

Instruction Set: The universal instruction set is standard on the Model 195.

Control Signal Exchange and External Interruption: The direct control feature is standard on the Model 195 and includes the external interrupt feature.

Main Storage: Part of 3195 Processing Unit

Storage Sizes:

CAPACITY (BYTES)	PROCESSOR MODEL	TYPE OF INTERLEAVING
1,048,576	J	8-way
2,097,152	K	16-way
3,145,728	KJ	8- or 16-way
4,194,304	L	16-way

Storage Cycle Time: 0.756 microsecond.

Storage Access Width: Eight bytes (one double-word).

High-Speed Buffer Storage: Most storage accesses are satisfied by this 32K-byte buffer storage, which in effect reduces the access time of most main storage accesses from 810 nanoseconds to 162. The buffer storage is controlled by an algorithm implemented in monolithic circuitry, thus its function is transparent to the programmer.

Storage Control Unit: This unit is the intermediary between main storage and the other system units. As such, it controls the accesses to the high-speed buffer storage and to main storage.

Channels: IBM 2860 Selector Channel Models 1-3, 2870 Multiplexer Channel, and 2880 Block Multiplexer Channel Models 1 and 2

The Model 195 can have as many as seven channels per CPU, contained within three to seven channel units (2860, 2870, and 2880 frames). The maximum combination of channels can be either:

1. One byte multiplexer channel and six selector and/or block multiplexer channels.

2. Two byte multiplexer channels and five selector and/or block multiplexer channels.

At least one channel is required. If the one channel is a 2870, it must have at least one selector subchannel.

Both the first and second 2870 have 192 byte multiplexer subchannels. The first 2870 can additionally have four selector subchannels, and a second 2870 can have two.

Interchannel Connection: A channel-to-channel adapter can be attached for each selector channel on the Model 195, permitting each selector channel to communicate with a byte or block multiplexer channel or with another selector channel. This adapter uses one control-unit position on each of the two channels.

System

System Control: The system controls are located on a stand-alone system console (considered part of the CPU). Integrated with the system console is a display console (similar to a 2250 Display Unit Model 1), which provides the operator with visual two-way communication with the system. The operator controls can also be duplicated at a remote panel on a 2150 Console.

Programming Support

The Model 195 is supported by a subset of OS with MVT.

Features and Characteristics	Application on Models								
	22	25	30	40	50	65	67	75	195
Central Processing Unit (CPU)									
CPU Model Number	2022	2025	2030	2040	2050	2065	2067	2075	3195
Basic Machine Cycle Time (nanoseconds)	750	900	750	625	500	200	200	195	54
Instruction Sets									
Standard (Std)	std	—	std	std	—	—	—	—	—
Commercial (Std and Decimal Arithmetic)	std	std	opt	opt	—	—	—	—	—
Scientific (Std and Floating-Point Arithmetic)	opt	opt	opt	opt	—	—	—	—	—
Universal (Std, Dec Arith, Floating-Point Arith, and Storage Protection)	opt	opt	opt	opt	std	std	std	std	std
Direct Control	—	opt	opt	opt	opt	opt	opt	std	std
Extended Direct Control (for Duplex Model 67-2)	—	—	—	—	—	—	opt	—	—
Extended-Precision Floating-Point Arithmetic	—	—	—	—	—	—	—	—	std
Byte-Oriented Operand	—	—	—	—	—	—	—	—	std
External Interrupt	opt	opt	opt	—	—	—	—	—	—
High-Speed Buffer Storage	—	—	—	—	—	—	—	—	std
Dynamic Address Translation	—	—	—	—	—	—	std	—	—
Time Sharing	—	—	—	—	—	—	yes	—	—
Timer									
Line-Frequency Type	opt	opt	opt	std	std	std	—	std	—
High-Resolution Type	—	—	—	—	—	—	std	—	std
Storage									
Storage Access Width (Number of Bytes Fetched per Access)	1	2	1	2	4	8	8	8	8
Storage Cycle Time (Microseconds)	1.5	1.8	1.5 ^(a)	2.5	2.0	0.75 ^(b)	0.75 ^(b)	0.75 ^(b)	0.756 ^(b)
Storage Interleaving	—	—	—	—	—	2-way	2-way	2 or 4-way	8 or 16-way
Store Protection	opt	opt	opt	opt	std	std	std	std	std
Fetch Protection	—	—	—	—	—	std	std	std	std
Shared Storage	—	—	—	—	—	opt	std on 67-2	—	—
Large-Capacity Storage (LCS) (2361 Core Storage)	—	—	—	—	opt	opt	—	opt	—
Shared LCS	—	—	—	—	opt ^(c)	opt ^(c)	—	opt ^(c)	—
Main Storage Capacities (in Bytes) ^(d)									
(Entries are Model Prefixes or Suffixes)									
16,384 = D	—	D	D	—	—	—	—	—	—
24,576 = DC	DC	DC	DC	—	—	—	—	—	—
32,768 = E	E	E	E	E	—	—	—	—	—
49,152 = ED	—	ED	—	—	—	—	—	—	—
65,536 = F	—	—	F	F	—	—	—	—	—
131,072 = G	—	—	—	G	G	—	—	—	—
196,608 = GF	—	—	—	GF	—	—	—	—	—
262,144 = H	—	—	—	H	H	H	-1, -2	H	—
393,216 = HG	—	—	—	—	HG	—	—	—	—
524,288 = I	—	—	—	—	I	I, MP	-1, -2	I	—
786,432 = IH	—	—	—	—	—	IH, MP	-1, -2	IH	—
1,048,576 = J	—	—	—	—	—	J, MP	-1, -2	J	J
1,310,720	—	—	—	—	—	MP	-2	—	—
1,572,864	—	—	—	—	—	MP	-2	—	—
1,835,008	—	—	—	—	—	MP	-2	—	—
2,097,152 = K	—	—	—	—	—	MP	-2	—	—
3,145,728 = KJ	—	—	—	—	—	—	—	—	K
4,194,304 = L	—	—	—	—	—	—	—	—	L
Compatibility Features (Entries are Model Prefixes or Suffixes)									
1401/1440/1460 DOS	—	DC, E, ED	DC, E, F	all	—	—	—	—	—
1401/1440/1460 Relocatable DOS	—	—	—	all	—	—	—	—	—
1401/1460	—	all	all	all but E	—	—	—	—	—
1410/7010	—	—	—	all but E	all	—	—	—	—
1440	—	all	all	—	—	—	—	—	—
1620	—	—	all	—	—	—	—	—	—
7070/7074	—	—	—	—	H, HG, I	all	—	—	—
7080	—	—	—	—	—	all	—	—	—
709/7040/7044/7090/7094 II	—	—	—	—	—	I, IH, J, MP	-1, -2	—	—
709/7090/7094/7094 II	—	—	—	—	—	—	—	—	—
Model 20 Mode	—	all	—	—	—	—	—	—	—

Figure 6-9. Comparison of IBM System/360 Models (Part 1 of 2)

Features and Characteristics	Application on Models								
	22	25	30	40	50	65	67	75	195
Programming Support									
Basic Operating System (BOS)	yes	yes	yes	yes	yes	yes	—	yes	—
Basic Programming System (BPS)	yes	yes	yes	yes	yes	yes	—	yes	—
Disk Operating System (DOS)	yes	yes	yes	yes	yes	yes	yes	yes	—
Operating System (OS)	—	—	yes	yes	yes	yes	yes	yes	yes
Tape Operating System (TOS)	yes	yes	yes	yes	yes	yes	yes	yes	—
Time-Sharing System (TSS)	—	—	—	—	—	—	yes	—	—
Channels									
Max. No. of Channels per CPU	2	1	3	3	4	7	7 ^g	7	7
With extended Channel Feature	—	—	—	—	—	—	—	—	14
Block Multiplexer	—	—	—	—	—	—	—	—	6
With Extended Channel Feature	—	—	—	—	—	—	—	—	13
Byte Multiplexer	1	1	1	1	1	2	2	2	2
Selector	1	1	2	2	3	6	6	6	6
Both Byte and Block Multiplexer	—	—	—	—	—	—	—	—	7
With Extended Channel Feature	—	—	—	—	—	—	—	—	14
Both Byte Multiplexer and Selector	2	1	3	3	4	7	7 ^g	7	7
Max. No. of Channel Units (Frames) per CPU	—	—	—	—	—	4	4	4	7
With Extended Channel Feature	—	—	—	—	—	—	—	—	8
2880 Block Multiplexer Channel	—	—	—	—	—	—	—	—	6
With Extended Channel Feature	—	—	—	—	—	—	—	—	8
2870 Multiplexer Channel (Byte Mpx)	—	—	—	—	—	2	2	2	2
2860 Selector Channel	—	—	—	—	—	2	2	2	6
Subchannels ^e (Type and No., Std or Opt) (n = nonshared, s = shared)									
Byte Multiplexer, of 1st Byte Mpx Channel									
32 n	—	all	—	E	—	—	—	—	—
64 n	—	—	—	F	—	—	—	—	—
96 n	all	—	all	—	—	—	—	—	—
128 n	—	—	—	G, GF, H	all	—	—	—	—
192 n	—	—	—	—	—	all	-1, -2	all	all
224 n	—	—	E, F	—	—	—	—	—	—
256 n	—	—	—	—	H, I	—	—	—	—
Byte Multiplexer, of 2nd Byte Mpx Channel									
192 n	—	—	—	—	—	all	-1, -2	all	all
Block Multiplexer, of Block Mpx Channels									
56 n (Max., with 1 s)	—	—	—	—	—	—	—	—	all
64 n (Max., with 0 s)	—	—	—	—	—	—	—	—	all
Selector, of 1st Byte Mpx Channel									
4 s	—	—	—	—	—	all	-1	all	all
8 s	—	—	—	—	—	—	-2	—	—
Selector, of 2nd Byte Mpx Channel									
2 s	—	—	—	—	—	H, I, IH, J	-1	all	all
Channel-to-Channel Adapter ^f									
	—	—	opt	opt	opt	opt	opt	opt	opt

std = standard
opt = optional
— = not applicable

Notes:

^a Main storage cycle time for some earlier Model 30's is 2.0 microseconds.

^b The storage cycle times given for Models 65-195 do not reflect the time reductions that are due to storage interleaving or, additionally for Model 195, the time reduction resulting from the use of the high-speed buffer.

^c A Model 50 can share LCS with any other Model 50 or with a Model 65 or 75 of equal or larger storage capacity. A Model 65 or 75 can share LCS with any other Model 65 or 75 of equal storage capacity or with a Model 50 with equal or less capacity.

^d The letters shown with the storage capacities are the model prefixes designating these capacities.

^e Shared subchannels can control several I/O devices or modules having a common control unit; nonshared subchannels can control only one I/O device.

^f For Models 30, 40, and 50, one channel-to-channel adapter may be installed per CPU. For Models 22 and 25, interchannel connection may be made with another system if the adapter is installed on the other system. On Models 65-195, an adapter may be installed for each selector channel installed.

^g The Model 67-2 can have as many as 14 channels (12 selector and two byte multiplexer) because it can have two 2846 Channel Controllers, each capable of controlling up to six selector channels and one byte multiplexer channel.

Figure 6-9. Comparison of IBM System/360 Models (Part 2 of 2)

Section 7. Input/Output Devices

A System/360 at any specific installation consists of a central processing unit, main storage, one or more I/O channels, and all online I/O equipment. Online means that the I/O equipment operates under program control. The following I/O devices and control units, arranged by category, can operate online as part of various System/360 models. Attachment information for the current IBM I/O devices and control units is given in the *IBM System/360 Input/Output Configurator*, GA22-6823.

Direct Access Devices

2301 Drum Storage
2303 Drum Storage
2305 Fixed Head Storage Models 1 and 2
2311 Disk Storage Drive
2312 Disk Storage Model A1
2313 Disk Storage Model A1
2314 Storage Control Models A1 and B1
2314 A-Series and B-Series Direct Access Storage Facility
2318 Disk Storage Model A1
2319 Disk Storage Models B1 and B2
2321 Data Cell Drive
2820 Storage Control
2835 Storage Control Models 1 and 2
2841 Storage Control
2844 Auxiliary Storage Control
3330 Disk Storage Model 1
3333 Disk Storage and Control Model 1
3830 Storage Control Models 1 and 2

Display Devices

2250 Display Unit Models 1 and 3
2840 Display Control Model 2
2260 Display Station Models 1 and 2
2848 Display Control Models 1-3, 21, 22
3272 Control Unit Models 1 and 2
3277 Display Station Models 1 and 2

Magnetic Character Readers

1255 Magnetic Character Reader Models 1-3
1419 Magnetic Character Reader

Magnetic Tape Devices

2401 Magnetic Tape Unit Models 1-6 and 8
2803 Tape Control Models 1, 2, and 3
2804 Tape Control Models 1, 2, and 3
2415 Magnetic Tape Unit and Control Models 1-6
2420 Magnetic Tape Unit Models 5 and 7
2816 Switching Unit Model 1

3410 Magnetic Tape Unit Models 1, 2, and 3
3411 Magnetic Tape Unit and Control Models 1, 2, and 3
3420 Magnetic Tape Unit Models 3, 5, and 7
3803 Tape Control Model 1

Magnetic Tape Cartridge Devices

2495 Tape Cartridge Reader

Manual Controls

1052 Printer-Keyboard Models 3, 5, 7, and 8
1051 Control Unit Models 1 and N1

Optical Readers

1231 Optical Mark Page Reader Model N1
1287 Optical Reader Models 1-5
1288 Optical Page Reader

Printers

1053 Printer Models 1 and 4
1403 Printer Models 2, 7, and N1
1404 Printer Model 2
1443 Printer Model N1
1445 Printer Model N1
2821 Control Unit Models 1-6
3211 Printer
3811 Printer Control Unit

Punched Card Devices

1442 Card Read Punch Model N1
1442 Card Punch Model N2
2501 Card Reader Models B1 and B2
2520 Card Read Punch Model B1
2520 Card Punch Models B2 and B3
2540 Card Read Punch
2560 Multi-function Card Machine Model A1
2596 Card Read Punch
3505 Card Reader Models B1 and B2
3525 Card Punch Models P1, P2, and P3

Punched Tape Devices

1017 Paper Tape Reader Models 1 and 2
1018 Paper Tape Punch
2671 Paper Tape Reader
2822 Paper Tape Reader Control
2826 Paper Tape Control Models 1 and 2

Systems

1800 Data Acquisition and Control System
2790 Data Communication System
3270 Information Display System

The following systems and devices are attachable online to various System/360 models as teleprocessing terminals. Most are attachable through the 2701 Data Adapter Unit, the 2702 or 2703 Transmission Control, or the 3704 or 3705 Communications Controller. Attachment information for the systems and devices is given in the *IBM System/360 Input/Output Configurator*, GA22-6823. For more information, see *IBM Teleprocessing System Summary*, GA24-3090, which contains brief descriptions of all IBM teleprocessing terminals, and *IBM SRL Bibliography Supplement—Teleprocessing and Data Collection*, GA24-3089, which contains a list of the pertinent IBM publications.

Transmission Control Devices

2701 Data Adapter Unit†
 2702 Transmission Control†
 2703 Transmission Control†
 3704 Communications Controller†
 3705 Communications Controller†

Modulator/Demodulator Units

2711 Line Adapter Unit
 3872 Modem
 3875 Modem
 4872 Modem Models 1, 2, and 3

Keyboard and Terminal Devices

1001 Data Transmission Terminal
 1013 Card Transmission Terminal

† A unit locally attached to a System/360 CPU, used to attach various terminals to System/360.

1092 Programmed Keyboard Models 1 and 2
 1093 Programmed Keyboard Models 1 and 2
 2740 Communication Terminal Models 1 and 2
 2741 Communication Terminal
 2780 Data Transmission Terminal Models 1-4

Display Devices

2260 Display Station Models 1 and 2
 2265 Display Station
 2845 Display Control
 2848 Display Control Models 1, 2, and 3
 3271 Control Unit Models 1 and 2
 3275 Display Station Models 1 and 2
 3277 Display Station Models 1 and 2

Audio Communications Devices

7770 Audio Response Unit Model 3†

Data Acquisition and Process Control Systems

1070 Process Communication System
 1800 Data Acquisition and Control System

Systems

1030 Data Collection System
 1050 Data Communication System
 1060 Data Communication System
 1130 Computing System
 2770 Data Communication System
 2790 Data Communication System
 3270 Information Display System
 3670 Brokerage Communication System
 3740 Data Entry System
 System/3 Models 6, 10, and 15
 System/7
 System/360 Models 20-195
 System/370 Models 115-195

Where more than one page reference is given, the major reference is first. See the end of the index for machine-numbered units.

- addressing, storage 2-3
- arithmetic
 - decimal 2-4
 - fixed-point 2-5
 - floating-point 2-5
 - operations 2-4
- arithmetic/logic unit 2-4
- assembler 4-3, 4-4
- asynchronous transmission in teleprocessing 5-2
- audio communications devices 8-1
- Autotest 4-1

- basic machine cycle time 6-20
- Basic Operating System (BOS) 4-2
- Basic Programming Support (BPS) 4-1
- Basic Telecommunications Access Method (BTAM) 4-2
- bits 2-1
- block multiplexer channels 2-7
 - for specific S/360 models (*see* System/360 models) 2880 2-7
- BOS (Basic Operating System) 4-2
- boundaries, integral 2-3
- boundary alignment 3-3
- BPS (Basic Programming Support) 4-1
- BTAM (Basic Telecommunications Access Method) 4-2
- buffer storage 3-4
- burst mode 2-7
- byte multiplexer
 - channels 2-7
 - for specific S/360 models (*see* System/360 models) modes of operation 2-7 2870 2-7
 - subchannels
 - shared 2-7
 - non-shared 2-7
- byte-oriented operand 3-3
- bytes 2-1

- central-processing units (CPU's)
 - comparison of 6-20
 - features 3-3
 - individual descriptions (*see* System/360 models) interconnection of 3-5
- channel facilities of each System/360 model
 - comparison of 6-21
 - (*see also* System/360 models)
- channels 2-6
 - block multiplexer 2-7
 - (*see also* block multiplexer channels)
 - byte multiplexer 2-7
 - (*see also* byte multiplexer channels)
 - of specific S/360 models (*see* System/360 models) selector 2-7
 - (*see also* selector channels)
- channel-to-channel adapter 3-4
- check bit (parity bit) 2-1
- COBOL 4-1
- codes 2-1
 - EBCDIC 2-2
- commercial instruction set 3-3
- communications lines 5-2
- comparison of System/360 models 6-20
- compatibility among System/360 models 1-2
- compatibility with other IBM systems
 - comparison of features for 6-20
 - features for 3-4
 - individual descriptions (*see* System/360 models)
- compiler 4-3
- control
 - panel 2-6
 - programs 2-8
 - as part of an operating system 4-2
 - introductory description of 1-1
 - units 2-8
- core storage (*see* main storage)
- CPU's (central processing units)
 - comparison of 6-20
 - features 3-3
 - individual descriptions (*see* System/360 models) interconnection of 3-5
- cycle, main storage (storage cycle time) 2-4

- data
 - access methods 4-1
 - fields
 - fixed-length 2-3
 - variable-length 2-3
 - files 4-1
 - formats 2-1
 - positioning 2-4
 - sets
 - programming 4-1
 - teleprocessing 5-3
- data acquisition
 - introduction to 5-3
 - systems 8-1
- data management 4-1
- decimal arithmetic 2-4
 - feature 3-3
- demodulation 5-3
- direct control feature 3-3
- disallowed interruptions 2-8
- Disk Operating System (DOS) 4-2
- display devices 7-1
 - teleprocessing 8-1
- DOS (Disk Operating System) 4-2
- doubleword 2-1
- duplex circuits in teleprocessing 5-2
- dynamic address translation 3-3

- EBCDIC (Extended Binary-Coded Decimal Interchange Code) 2-2
- editing of data 2-5
- emergency power-off control 3-4
- emulators 3-5
- Extended Binary-Coded Decimal Interchange Code (EBCDIC) 2-2
- extended-precision floating-point arithmetic 3-3
- external interrupt feature 3-3
- external interruptions 2-8

- facilities of BOS, TOS, and DOS 4-4
- fetch protection 3-1
- fixed-point arithmetic 2-5

- floating-point arithmetic 2-5
 - extended-precision (feature) 3-3
 - feature 3-3
- floating-point registers 2-4
- floating storage addressing 6-14
- formats
 - data 2-1
 - instruction 2-5
- FORTRAN 4-1
- fractions, floating-point 2-5
- full-duplex circuits in teleprocessing 5-2
- fullword (same as word) 2-1

- general registers 2-4

- half-duplex circuits in teleprocessing 5-2
- halfword 2-1
- high-resolution timer 3-4
- high-speed buffer storage 3-4

- ICA (integrated communications attachment) 6-4
- instruction
 - addressing 2-5
 - formats 2-5
 - length 2-5
- instruction sets 3-3
- integral boundaries 2-3
- integrated communications attachment (ICA) 6-4
- integrated I/O attachment 6-3
- interface, System/360 I/O 2-8, 1-1
- interleaving 2-4
 - in LCS 3-1
- interrupt 2-9
 - external (feature) 3-3
- interruption systems
 - introductory description 1-1
 - operation 2-8
- interruptions
 - classes 2-8
 - disallowing 2-9
- interrupts 2-8
- interval timer 3-4
- I/O
 - attachable 7-1
 - control of 2-6
 - interface 2-7, 1-1
 - interruptions 2-9
- IOCS (Input/Output Control System) 4-3, 4-4
- IPL (initial program load) 4-4, 4-3

- job management 4-1

- K(=1,024) 2-4, 4-2

- language translators 4-1
- large-capacity storage (LCS) 3-1
- LCS (large-capacity storage) 3-1
- line adapter 5-3
- line-frequency timer 3-4
- linkage editor 4-3, 4-4
- load module 4-3
- logic operations 2-5

- machine-check interruptions 2-9
- macro instruction 4-3, 4-4
- magnetic ink devices 7-1
- magnetic tape devices 7-1

- main storage
 - comparison for each S/360 model 6-20
 - features 3-1
 - in individual S/360 models (*see* System/360 models)
 - shared 3-1
 - structure of 2-2
- MFT (Multiprogramming with a Fixed Number of Tasks) 4-2
- modem in teleprocessing 5-3
- modulation 5-3
- module
 - load 4-3
 - object 4-3, 4-4
- multipath control units 2-8
- multiplexer (*see* byte multiplexer)
- multiprocessing for Model 65 6-11
- Multiprogramming 4-2
 - with a Fixed Number of Tasks (MFT) 4-2
 - with a Variable Number of Tasks (MVT) 4-2
- MVT (Multiprogramming with a Variable Number of Tasks) 4-2

- object module 4-3, 4-4
- on-line I/O devices 7-1
- op codes (operation codes) 2-6
- operating systems, general facts 4-1
- Operating System (OS) 4-2
- operation codes (op codes) 2-6
- operator controls 2-6
- optical readers 7-1
- OS (Operating System) 4-2

- packed format (decimal arithmetic) 2-4
- parallel transmission in teleprocessing 5-2
- parity bit (check bit) 2-1
- partitioning
 - sensing 6-13
 - system 3-5
- PCP (Primary Control Program) 4-2
- PL/I 4-1
- point-to-point communications lines 5-2
- positioning of data 2-3
- Primary Control Program (PCP) 4-2
- printers 7-1
- problem programs (processing programs) 4-2
- process control
 - introduction to 5-3
 - systems 8-1
- processing programs (problem programs) 4-2
- processing units (*see* CPU's)
- processor storage 3-1
 - (*see also* main storage)
- processors (*see* CPU's)
- program
 - interruptions 2-8
 - library 4-3
 - relocation, in teleprocessing 5-2
- program status word (PSW) 2-8
- programming support for individual S/360 models
 - comparison of 6-20
 - (*see also* System/360 models)
- programming systems 4-1
 - glossary 4-3
- protection
 - key 3-1
 - storage 3-1
- PSW (program status word) 2-8
- punched card devices 7-1
- punched tape devices 7-1

- Recovery Management Support (*see* RMS programs)
- registers 2-4
- Report Program Generator (RPG) 4-1
- RMS (Recovery Management Support) programs
 - for Model 65 6-12
- RPG (Report Program Generator) 4-1
- RR instruction format 2-5
- RS instruction format 2-5
- RX instruction format 2-5

- scientific instruction set 3-3
- selector
 - channels 2-7
 - of specific S/360 models (*see* System/360 models)
 - 2860 2-7
 - subchannels 2-7
 - service programs 4-1
 - shared main storage 3-1
 - shared-path control units 2-8
 - shared subchannels 2-7
 - SI instruction format 2-6
 - simplex circuits in teleprocessing 5-2
 - simulators 3-5
 - special systems support 4-1
 - SS instruction format 2-6
 - standard instruction set 3-3
 - storage
 - addressable 2-4
 - addressing 2-3
 - buffer 3-4
 - cycle time 2-4
 - main (*see* main storage)
 - protection 3-1
 - in teleprocessing 5-2
 - store protection 3-1
 - supervisor call interruption 2-8
 - supervisor (task management) 4-1
 - system
 - control panel 2-6
 - control section 2-4
 - generation 4-1
 - manual control 2-6
 - partitioning 3-5
 - System/3 8-1
 - System/7 8-1
 - System/360
 - addressing capability 2-3
 - applications 1-1
 - basic structure 2-1
 - general-purpose design 1-1
 - high reliability 1-2
 - open-ended design 1-1
 - self-supervision capabilities 1-1
 - system compatibility 1-1
 - System/360 models
 - comparison of 6-20
 - description of
 - Model 22 6-1
 - Model 25 6-3

- System/360 models (*continued*)
 - Model 30 6-5
 - Model 40 6-7
 - Model 50 6-9
 - Model 65 6-11
 - Model 67 6-13
 - Model 75 6-16
 - Model 195 6-18
- System/360 operating systems 4-1

- Tape Operating System (TOS) 4-2
- task management (supervisor) 4-1
- teleprocessing
 - introduction to 5-1
 - systems and devices 8-1
- terminal connections in teleprocessing
 - multipoint 5-2
 - point-to-point 5-2
- terminals in teleprocessing 8-1, 5-2
- time sharing 3-4
- Time-Sharing System (TSS) 6-15
- timer 3-4
- TOS (Tape Operating System) 4-2
- translation of characters 2-5
- translators 4-1
- transmission control devices 8-1
- transmission control in teleprocessing 5-2
- transmission modes in teleprocessing 5-2
- TSS (Time-Sharing System) for Model 67 6-15

- universal instruction set 3-3
- utility programs 4-1

- word (fullword) 2-1

- zoned format (decimal arithmetic) 2-4

- 2167 Configuration Unit
 - in system partitioning 3-5
 - in Model 67-2 6-14
- 2361 Core Storage 3-1
 - for Model 50 6-10
 - for Model 65 6-11
 - for Model 75 6-16
- 2365 Processor Storage
 - for Model 65 6-11
 - for Model 67 6-14
 - for Model 75 6-16
- 2741 Communication Terminal used with a Model 67-2 6-14
- 2846 Channel Controller, in Model 67-2 6-14
- 2860 Selector Channel 2-7
- 2870 Multiplexer Channel 2-7
- 2880 Block Multiplexer 2-8

IBM System/360 System Summary
Order No. GA22-6810-12

**READER'S
COMMENT
FORM**

Your views about this publication may help improve its usefulness; this form will be sent to the author's department for appropriate action. Using this form to request system assistance or additional publications, however, will delay response. For more direct handling of such request, please contact your IBM representative or the IBM Branch Office serving your locality.

Possible topics for comment are:

Clarity Accuracy Completeness Organization Index Figures Examples Legibility

— Cut or Fold Along Line —

What is your occupation? _____

Number of latest Technical Newsletter (if any) concerning this publication: _____

Please indicate in the space below if you wish a reply.

Thank you for your cooperation. No postage stamp necessary if mailed in the U.S.A. (Elsewhere, an IBM office or representative will be happy to forward your comments.)

Your comments, please . . .

This manual is a reference source for systems analysts, programmers and operators of IBM systems. Your comments will help us produce better publications for your use. Each reply will be carefully reviewed by the persons responsible for writing and publishing this material. All comments and suggestions become the property of IBM.

Cut or Fold Along Line

Fold

Fold

Business Reply Mail
No postage stamp necessary if mailed in U.S.A.

FIRST CLASS
PERMIT NO. 419
POUGHKEEPSIE, N.Y.

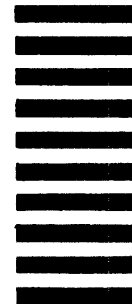

Postage will be paid by:
International Business Machines Corporation
Department B98
P.O. Box 390
Poughkeepsie, New York 12602

Fold

Fold

System/360 System Summary Printed in U.S.A. GA22-6810-12



International Business Machines Corporation
Data Processing Division
1133 Westchester Avenue, White Plains, New York 10604
(U.S.A. only)

IBM World Trade Corporation
821 United Nations Plaza, New York, New York 10017
(International)

GA22-6810-12





International Business Machines Corporation
Data Processing Division
1133 Westchester Avenue, White Plains, New York 10604
(U.S.A. only)

IBM World Trade Corporation
821 United Nations Plaza, New York, New York 10017
(International)